

# **TDZ 2000 GL2/ExtremeZ GL2**

## *System Setup*

---

November 1998

DHA028420

**INTERGRAPH**  
**COMPUTER SYSTEMS**

## Copyright

© 1998 Intergraph Computer Systems. All rights reserved. This document contains information protected by copyright, trade secret, and trademark law. This document may not, in whole or in part, be reproduced in any form or by any means, or be used to make any derivative work, without written consent from Intergraph Computer Systems.

Use, duplication, or disclosure by the United States Government is subject to restrictions as set forth in subdivision (c)(1)(ii) of the rights in technical data and computer software clause at DFARS 252.227-7013. Unpublished rights are reserved under the copyright laws of the United States.

Intergraph Computer Systems, Huntsville AL 35894-0001

## Notice

Information in this document is subject to change without notice and should not be considered a commitment by Intergraph Computer Systems. Intergraph Computer Systems shall not be liable for technical or editorial errors in, or omissions from, this document. Intergraph Computer Systems shall not be liable for incidental or consequential damages resulting from the furnishing or use of this document.

All warranties given by Intergraph Computer Systems about equipment or software are set forth in your purchase contract. Nothing stated in, or implied by, this document or its contents shall be considered or deemed a modification or amendment of such warranties.

## Trademarks

Intergraph Computer Systems and the Intergraph Computer Systems logo are registered trademarks, and Ultra-Tower, TD, TDZ, and Intense 3D are trademarks of Intergraph Computer Systems. Other brands and product names are trademarks of their respective owners.

## FCC/DOC Compliance

This equipment has been tested and found to comply with the limits for a Class B digital device, pursuant to part 15 of the FCC Rules. These limits are designed to provide reasonable protection against harmful interference when the equipment is operated in a residential installation. This equipment generates, uses, and can radiate radio frequency energy. If the equipment is not installed and used in accordance with the instructions, it may cause harmful interference to radio communications. However, there is no guarantee that interference will not occur in a particular installation.

If this equipment does cause harmful interference to radio or television reception, which can be determined by turning the equipment off and on, try to correct the interference as follows: reorient or relocate the affected device; increase the separation between this equipment and the affected device; connect this equipment to an outlet on a circuit different from the circuit to which the affected device is connected; consult a dealer or an experienced radio/television technician for help.

This Class B digital apparatus meets all requirements of the Canadian Interference-Causing Equipment Regulations. Cet appareil numérique de la classe B respecte toutes les exigences du Règlement sur le matériel brouilleur du Canada.

## Warnings

The service and upgrade instructions should be performed by qualified personnel only. Qualified personnel do not have to be Intergraph service personnel. Those who are familiar with servicing computers can follow instructions in a manual to service equipment, and do so without harm to themselves or damage to the equipment.

Changes or modifications made to the system that are not approved by the party responsible for compliance could void the user's authority to operate the equipment.

To reduce the risk of electrical shock, do not attempt to open the equipment unless instructed. Do not use a tool for purposes other than instructed.

There is a danger of explosion if the battery is incorrectly replaced. Replace the battery only with the same or equivalent type as recommended by the manufacturer. Dispose of used batteries according to the manufacturer's instructions.

There are no user serviceable parts within the power supply. In the event of failure, the power supply must be replaced by qualified service personnel. Use Intergraph power supplies only.

To comply with FCC Class B limits, you must use shielded cables with this device.

**Notes**

This device is designed and manufactured to comply with approved safety standards for information processing and business equipment.

Read all operating instructions before using this device. Keep these instructions for future reference. Follow all warnings on the device or in the operating instructions.



# Contents

|  |           |
|--|-----------|
| <b>Preface.....</b>                            | <b>ix</b> |
| About This Document.....                       | ix        |
| Document Conventions.....                      | ix        |
| Finding Operating System Information.....      | x         |
| Finding System Hardware Information.....       | x         |
| Learning About System Ergonomics.....          | x         |
| Customer Support.....                          | xi        |
| Hardware and Software Support Services.....    | xi        |
| World Wide Web.....                            | xi        |
| Intergraph Bulletin Board Service.....         | xi        |
| FAXLink.....                                   | xii       |
| Telephone.....                                 | xii       |
| More Support Options.....                      | xiii      |
| <b>1 Setting Up the Hardware.....</b>          | <b>1</b>  |
| Handling the Base Unit.....                    | 2         |
| Opening and Closing the Door.....              | 2         |
| Unpacking the System.....                      | 3         |
| Placing System Components.....                 | 4         |
| Setting Up the System.....                     | 5         |
| Installed Expansion Cards.....                 | 7         |
| Connecting Speakers and a Microphone.....      | 8         |
| Connecting an External SCSI Device.....        | 8         |
| Starting the System.....                       | 9         |
| What's Next?.....                              | 10        |
| <b>2 Setting Up the Software.....</b>          | <b>11</b> |
| Preparing for System Software Setup.....       | 12        |
| Starting Operating System Setup.....           | 14        |
| Finishing System Software Setup.....           | 15        |
| Creating a Repair Disk.....                    | 16        |
| Creating System Software Backup Diskettes..... | 16        |
| What's Next?.....                              | 17        |
| <b>3 Configuring the System.....</b>           | <b>19</b> |
| Configuring the Video Display.....             | 20        |
| Resetting the Video Display Resolution.....    | 20        |
| Correcting Video Display Problems.....         | 21        |
| Configuring Audio.....                         | 22        |
| Configuring Networking.....                    | 22        |
| Configuring a CD-Recorder Drive.....           | 23        |
| Configuring a Tape Drive.....                  | 23        |
| Configuring a Zip or Jaz Drive.....            | 23        |

---

|   |           |
|---|-----------|
| Configuring a Modem.....                                      | 24        |
| Configuring a PC Card Adapter .....                           | 24        |
| Changing Hard Disk Drive Letters (Windows NT).....            | 25        |
| Changing Virtual Memory Settings (Windows NT) .....           | 25        |
| Getting Operating System Updates.....                         | 26        |
| <b>4 Operating Notes .....</b>                                | <b>27</b> |
| System Power, Startup, and Shutdown .....                     | 28        |
| Using the Standby Button.....                                 | 28        |
| System Power States.....                                      | 29        |
| Automatic Shutdown Utility (Windows NT).....                  | 30        |
| Starting and Shutting Down the System .....                   | 32        |
| Observing Operating Precautions .....                         | 33        |
| Using the Keyboard .....                                      | 33        |
| Using the Mouse.....  | 35        |
| Using the Floppy Disk Drive.....                              | 35        |
| Using the CD-ROM Drive .....                                  | 36        |
| Using InterSite Programs .....                                | 36        |
| Updating an Emergency Repair Disk or a Startup Diskette ..... | 37        |
| Ensuring PC Card Support and Operation (Windows NT) .....     | 38        |
| Booting from an External SCSI Disk Drive .....                | 38        |
| Using Hardware Security Features .....                        | 39        |
| Finding Serial and Model Numbers.....                         | 40        |
| Cleaning the System .....                                     | 40        |
| <b>5 Configuring the BIOS .....</b>                           | <b>41</b> |
| Introduction .....  | 42        |
| Standard CMOS Setup.....                                      | 43        |
| Advanced CMOS Setup .....                                     | 44        |
| Advanced Chipset Setup .....                                  | 48        |
| Power Management Setup.....                                   | 52        |
| PCI/Plug and Play Setup .....                                 | 55        |
| Peripheral Setup .....  | 57        |
| Auto-Detect Hard Disks.....                                   | 59        |
| Change Supervisor Password .....                              | 59        |
| Change User Password.....                                     | 59        |
| Change Language Setting .....                                 | 59        |
| Auto Configuration with Optimal Settings .....                | 59        |
| Auto Configuration with Fail-Safe Settings .....              | 60        |
| Save Settings and Exit .....                                  | 60        |
| Exit Without Saving .....                                     | 60        |
| Updating the System BIOS .....                                | 60        |
| <b>6 Troubleshooting.....</b>                                 | <b>61</b> |
| System Power .....  | 62        |
| System Boot.....  | 62        |

---

|   |           |
|---|-----------|
| Sound .....   | 65        |
| Video.....  | 66        |
| Miscellaneous Hardware .....  | 66        |
| Network.....  | 67        |
| <b>7 Reinstalling System Software .....</b>                                 | <b>69</b> |
| Before You Begin .....  | 70        |
| System Software Products.....   | 71        |
| TDZ 2000 GL2 .....  | 71        |
| ExtremeZ GL2 .....  | 72        |
| Installing Windows NT Workstation 4.0 .....                                 | 73        |
| Disabling Command Queuing .....   | 74        |
| Enabling Bus Mastering for IDE/ATAPI Devices .....                          | 75        |
| Installing the Creative Labs Sound Blaster Pro 16 Driver .....              | 75        |
| Installing Windows 95 or Windows 98.....                                    | 76        |
| Installing the Creative Labs Sound Blaster Pro 16 Driver .....              | 77        |
| Installing Windows 95 or Windows 98 with an Installed Network Adapter ..... | 78        |
| Enabling Bus Mastering for IDE/ATAPI Devices .....                          | 78        |
| Disabling the Active Desktop .....  | 79        |
| Updating the Operating System.....  | 79        |
| <b>8 Using System Resources.....</b>  | <b>81</b> |
| System Resources.....   | 82        |
| ISA Bus Interrupt (IRQ) Assignments .....                                   | 82        |
| Direct Memory Access (DMA) Channels.....                                    | 82        |
| Input/Output (I/O) Addresses .....  | 82        |
| Memory Addresses.....   | 84        |
| Using System Resources.....   | 85        |
| PCI Devices.....  | 86        |
| <br>  |           |
| Returned Goods Authorization (RGA) Form                                     |           |
| Warranty Procedure  |           |
| Repair Depot Address Labels   |           |





---

# Preface

*TDZ 2000 GL2/ExtremeZ GL2 System Setup* describes setting up and configuring your TDZ 2000 GL2 or ExtremeZ GL2 system for use. This document also provides information on operating the system, troubleshooting, and reinstalling system software.

**NOTE** If you have an ExtremeZ workstation, see the *ExtremeZ Customer Welcome Letter* first. The *ExtremeZ Customer Welcome Letter* provides step-by-step instructions for initial setup of an ExtremeZ workstation.

## About This Document

This document is organized as follows:

- ◆ Chapter 1, “Setting Up the Hardware,” describes how to set up the system hardware.
- ◆ Chapter 2, “Setting Up the Software,” describes how to set up the operating system and associated system software.
- ◆ Chapter 3, “Configuring the System,” describes how to configure the system for use.
- ◆ Chapter 4, “Operating Notes,” describes how to use essential system features and provides other important basic information.
- ◆ Chapter 5, “Configuring the BIOS,” describes how to use BIOS Setup to configure the system’s basic input/output system (BIOS).
- ◆ Chapter 6, “Troubleshooting,” describes how to resolve common system problems.
- ◆ Chapter 7, “Reinstalling System Software,” describes how to reinstall the operating system and associated system software, if required.
- ◆ Chapter 8, “Using System Resources,” provides information on using system resources.

## Document Conventions

|               |   |
|---------------|---|
| <b>Bold</b>   | Commands, words, or characters that you key in literally.   |
| <i>Italic</i> | Variable values that you supply, or cross-references.   |
| Monospace     | Output displayed on the screen.   |
| SMALL CAPS    | Key names on the keyboard, such as D, ALT or F3; names of files and directories. You can type filenames and directory names in the dialog boxes or the command line in lowercase unless directed otherwise. |

CTRL+D      Press a key while simultaneously pressing another key; for example, press CTRL and D simultaneously.

## Finding Operating System Information

For more detailed information on the operating system, see the printed and online Microsoft documentation delivered with the system.

See the *Late-Breaking News* shipped with your system for important software and documentation information not covered in this document.

## Finding System Hardware Information

Detailed reference information for your new system is provided in the *System Reference*, which covers subjects such as the following:

- ◆ Opening and closing the unit
- ◆ Precautions against electrostatic discharges
- ◆ Replacing and upgrading system components
- ◆ Installing expansion cards
- ◆ Power supply information

A *System Board Manual* is shipped with each system, and provides detailed information about the following:

- ◆ System board layout and components
- ◆ External port and system board connectors
- ◆ Replacing and upgrading system board components

See the *Late-Breaking News* shipped with your system for important hardware and documentation details not covered in this document.

## Learning About System Ergonomics

Please read the *Ergonomics Guide* included with your Intergraph computer system. This document provides valuable information on ways to minimize repetitive stress injuries for people working with computers.

---

# Customer Support

Intergraph Computer Systems offers an assortment of customer support options.

## Hardware and Software Support Services

Intergraph Computer Systems provides a variety of hardware services for Intergraph and third-party equipment. Services include warranty upgrades, repair depot service, on-site hardware maintenance, system administration, and network consulting. Hardware purchased from Intergraph Computer Systems includes a factory warranty ranging from 30 days to three years. A detailed warranty description is available on the World Wide Web; see the Support pages at <http://www.intergraph.com/ics>.

Intergraph Computer Systems provides complimentary software support for 30 or 90 days following shipment of a hardware or software product. This includes World Wide Web access, Intergraph Bulletin Board Service access, FAXLink service, and telephone (Help Desk) support. At the end of the complimentary support period, you may purchase other levels of software support.

## World Wide Web

You can visit Intergraph Computer Systems on the World Wide Web at <http://www.intergraph.com/ics>. On these pages, you can get news and product information, technical support information, software updates and fixes, and more.

## Intergraph Bulletin Board Service

On the Intergraph Bulletin Board Service (IBBS), you can get technical support information, software updates and fixes, and more.

### To connect to the IBBS:

1. Set your system's communications protocol for eight (8) data bits, no parity, one (1) stop bit, and any baud rate up to 14,400.
2. Using a modem, call 1-256-730-8786. Outside the United States, call one of the mirror sites listed on World Wide Web; see the software support pages at <http://www.intergraph.com>.
3. At the login prompt, key in your user ID. If you have not connected before, key in **new** to create a user ID.
4. Follow the menus to find what you need. The IBBS provides clear choices and online help.

If you have trouble connecting to or using the IBBS, call the Customer Response Center at 1-800-633-7248 (product entry IBBS) or leave a message for the IBBS System Operator at 1-256-730-1413.

## **FAXLink**

### **To use the FAXLink:**

- ◆ Call 1-800-240-4300 for information on how to get technical support information using the FAXLink.
- ◆ Call 1-256-730-9000 to get documents (up to five per call).

## **Telephone**

### **To get customer support by telephone:**

- ◆ In the United States, call 1-800-633-7248 between the hours of 7:00 a.m. and 7:00 p.m. Central Time, Monday through Friday (except holidays).
- ◆ Outside the United States, contact your local Intergraph Computer Systems subsidiary or distributor.

### **Have the following information available when you call:**

- ◆ Your service number, which identifies your site to Intergraph Computer Systems. You use your service number for warranty or maintenance calls.
- ◆ Your Customer Personal Identification Number (CPIN). You get a CPIN the first time you call the Customer Response Center; it is associated with your service number for future call logging.
- ◆ The product's name or model number.
- ◆ The product's serial number. Software product serial numbers are included in the product packaging. Hardware product serial numbers are on a sticker affixed to the hardware product.
- ◆ Your name and telephone number.
- ◆ A brief description of the question or problem.

## More Support Options

**To get information on more customer support options:**

- ◆ Visit the Support pages on the World Wide Web at <http://www.intergraph.com/ics>.
- ◆ For hardware support questions in the United States, call 1-800-763-0242.
- ◆ For software support questions in the United States, call 1-800-345-4856.
- ◆ Outside the United States, contact your local Intergraph Computer Systems subsidiary or distributor.



---

# 1 Setting Up the Hardware

Follow the instructions in this chapter to set up the hardware for your TDZ 2000 GL2 or ExtremeZ GL2 workstation.

**NOTE** If you have an ExtremeZ workstation, see the *ExtremeZ Customer Welcome Letter* first. The *ExtremeZ Customer Welcome Letter* provides step-by-step instructions for initial setup of an ExtremeZ workstation.

|   |    |
|---|----|
| Handling the Base Unit .....              | 2  |
| Opening and Closing the Door .....        | 2  |
| Unpacking the System .....                | 3  |
| Placing System Components .....           | 4  |
| Setting Up the System.....                | 5  |
| Installed Expansion Cards .....           | 7  |
| Connecting Speakers and a Microphone..... | 8  |
| Connecting an External SCSI Device .....  | 8  |
| Starting the System .....                 | 9  |
| What's Next? .....                        | 10 |

## Handling the Base Unit

**WARNING** Do not use the bottom portion of the face panel or the lip at the top rear of the base unit as a hand hold when moving the base unit. Equipment damage and personal injury can result.

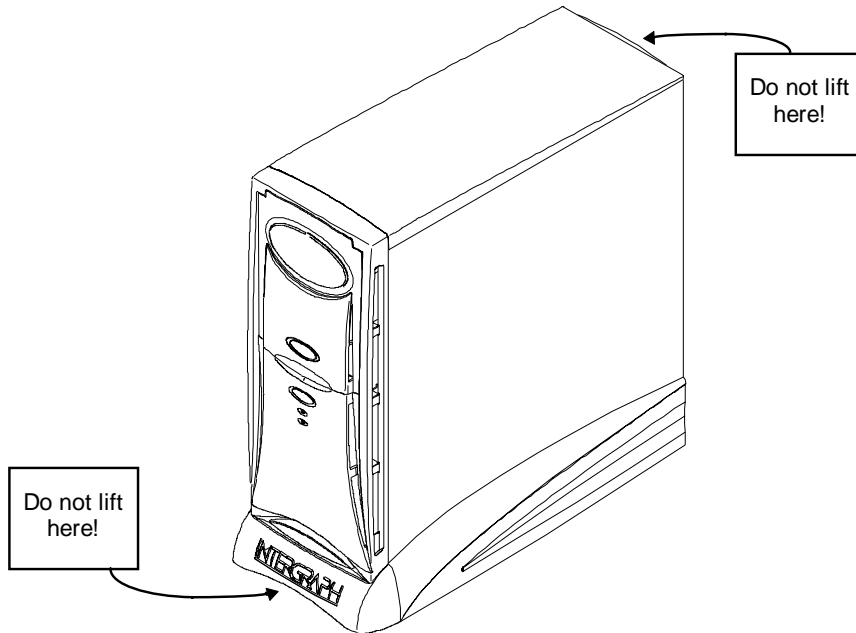

## Opening and Closing the Door

Open the door on the system's front panel to gain access to the Standby button, the floppy disk drive, the CD-ROM drive, and any optional peripheral device installed in the external device bay. You can use your system with the door open or closed. See the following figure for more details.

### To open and stow the door:

1. Grasp the lip at the bottom of the door and lift up until the door is even with the top of the unit.
2. Push the door into the case until the door stops.



**To close the door:**

1. Grasp the door and pull it straight out of the case until it stops.
2. Lower the door until it stops and press gently until the door clicks into place.

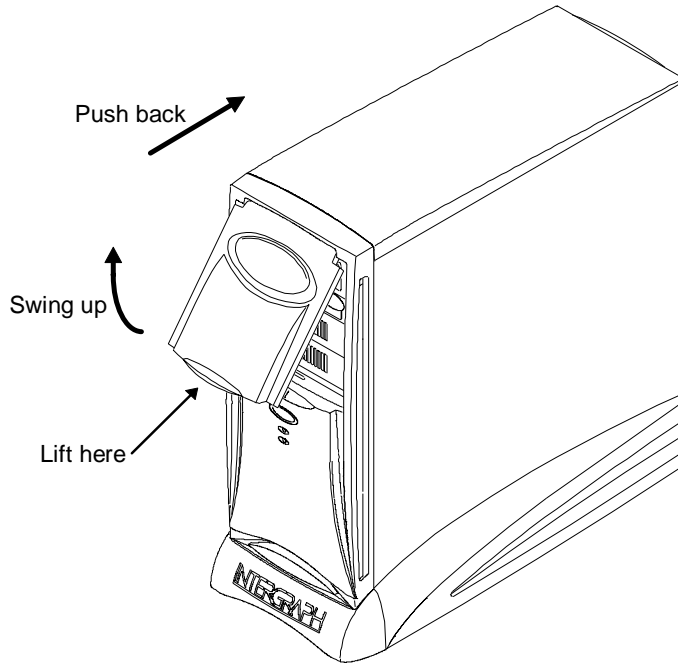

## Unpacking the System

**CAUTION** Carefully remove items from packaging. Do not drop items on a hard surface or damage may result. You may need help to unpack and place heavy items.

Remove everything from the shipping cartons, then look for the following items:

- ◆ Workstation and power cord
- ◆ Keyboard and mouse
- ◆ Intergraph Computer Systems documentation
- ◆ Operating system software (CD-ROM and diskettes) and documentation
- ◆ Documentation for various peripheral devices
- ◆ A monitor with video cable, power cord, and documentation (if purchased from Intergraph Computer Systems)

**NOTE** If any of these items were not delivered, call the Customer Response Center immediately at 1-800-633-7248.

Save the packaging materials. If you need to return equipment for repair, it must be in its original packaging for you to get warranty service.

If you have already unpacked and connected the peripherals to the system, review the rest of this chapter and then go to Chapter 2, “Setting Up the Software.”

## Placing System Components

**CAUTION** Do not use the bottom portion of the face panel or the lip at the top rear of the unit as a hand hold when moving the system. Equipment damage and personal injury can result.

When placing the system’s components, remember these guidelines:

- ◆ Move and place the base unit and monitor carefully.
- ◆ Place the base unit in a location where air can circulate freely around it. The front and back panels should each have at least a 3-inch clearance.
- ◆ Avoid exposing the system to high levels of dust, smoke, or moisture.
- ◆ Maintain a temperature range of 10 °C to 26 °C (50 °F to 80 °F); the optimum operating temperature is 21 °C (70 °F).
- ◆ Maintain a humidity range from 20 percent to 80 percent (non-condensing); the optimum humidity level is 50 percent.

**CAUTION** Do not move the system without first shutting down the system and turning off the power, or damage to internal components may result.

# Setting Up the System



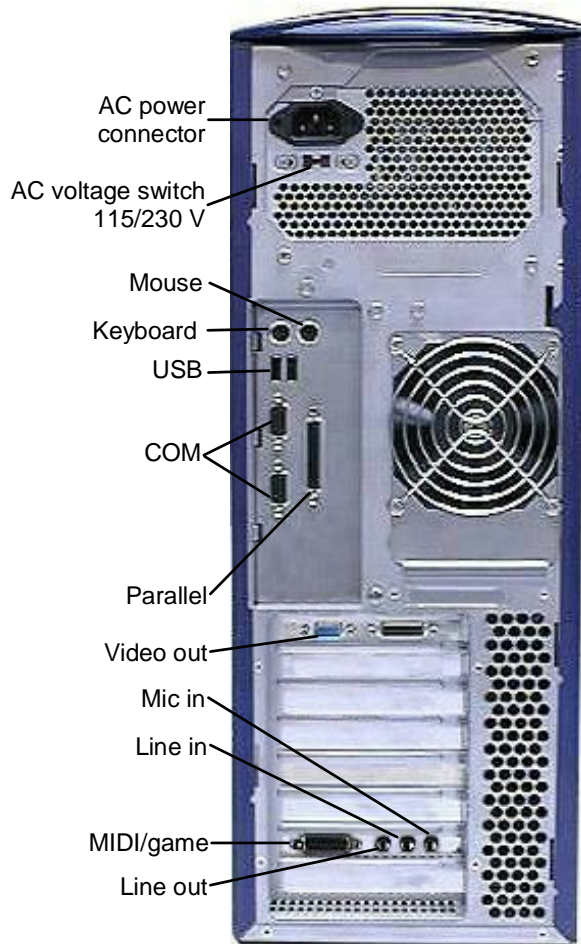







Before you connect any cables to the back of the system, note the connector locations in the following illustration.



See the *System Reference* for technical details on each port.

### To set up the system:

1. Arrange the system base unit, monitor, keyboard, and other peripherals in your workspace.
2. Connect the cables from the various peripherals to the ports on the back of the system.

| <u>Connect the cable from this...</u>                                 | <u>To the port labeled...</u>   | <u>For this connector...</u>                 |
|---|---|--|
| Mouse   |    | Mouse port                                   |
| Keyboard  |    | Keyboard port                                |
| Modem, printer, or other device                                       |  <sup>1</sup>  <sup>2</sup> | Serial (COM) port 1 or 2                     |
| Printer or other device   |    | Parallel (LPT) port                          |
| Universal Serial Bus device   |    | Universal Serial Bus port                    |
| Stereo speakers or headphones;<br>multimedia keyboard speaker         |    | Line Out port on sound card                  |
| External stereo cassette or CD player;<br>radio or other audio device |    | Line In port on sound card                   |
| Multimedia keyboard microphone,<br>separate microphone                |    | Microphone port                              |
| Game joystick or MIDI device  |    | MIDI/Game port                               |
| Monitor   |    | Video Out port on video display adapter card |

**WARNING** If you do not use cables supplied by Intergraph Computer Systems, you must use shielded cables to prevent excessive electromagnetic interference (EMI). Intergraph Computer Systems cables are designed to reduce the amount of EMI produced by the system.

3. If the system includes a multimedia option, connect the speakers and microphone or the multimedia keyboard to the audio card. See “Connecting Speakers and a Microphone” in this chapter for details.

4. If the system includes an optional SCSI adapter card, connect any external SCSI devices to the external SCSI port on this card. See “Connecting an External SCSI Device” in this chapter for details.
5. Make sure that the AC voltage switch on the back panel of the base unit is set to the proper line voltage for your location. If your location uses 115 volts, make sure the number **115** is visible on the switch. If your location uses 230 volts, make sure the number **230** is visible on the switch. See the previous figure.

**WARNING** If you do not set the AC voltage switch correctly, serious equipment damage may result when you turn on power to the system.

6. Connect the power cords from the monitor, system, and any external optional peripherals to receptacles on a grounded, three-prong AC wall outlet.
7. Open and stow the door on the front of the computer by doing the following:
  - Grasp the lip at the bottom of the door, pull forward slightly, and lift up until the door is even with the top of the system
  - Push the door into the system until the door stops

## Installed Expansion Cards

Expansion cards are installed in the Accelerated Graphics Port (AGP), Peripheral Component Interconnect (PCI), and Industry Standard Architecture (ISA) expansion slots in the base unit. If you purchased expansion cards from Intergraph Computer Systems, they are installed in specific slots as follows.

| Slot   | Type                   | Expansion Card   |
|--------|------------------------|--|
| Top    | AGP                    | Video display adapter  |
|        | PCI                    | Video display adapter (optional; for multi-screen)   |
|        | PCI                    | Video display adapter (optional; for multi-screen)   |
|        | PCI                    | Video display adapter (optional; for multi-screen)<br>SCSI adapter (optional)  |
|        | PCI                    | Video display adapter (optional; for multi-screen)   |
|        | PCI or ISA<br>(shared) | Network adapter (optional)<br>Sound adapter (if optional network adapter is not installed)   |
| Bottom | ISA                    | Sound adapter (if optional network adapter is installed)<br>PC Card adapter (optional; no external connection)<br>56K modem (optional) |

## Connecting Speakers and a Microphone

If the system includes separate powered speakers and a microphone, connect the speakers to the Line Out port on the audio card, and connect the microphone to the Microphone port on the audio card. Connect the speaker power AC adapter to the appropriate speaker(s), and then to a grounded, three-prong AC wall outlet. See the audio card documentation delivered with the system for more detailed connection information.

If the system includes a multimedia keyboard, see the multimedia keyboard documentation delivered with the system for connection information.

## Connecting an External SCSI Device

Two SCSI adapters are available as options for the TDZ 2000 GL2: a dual channel Ultra Wide option, and a single channel Low-Voltage Differential (LVD) option. If your system includes one of these SCSI adapters, you can connect internal and external SCSI devices, such as hard disk drives or tape drives, to the system. Internal SCSI devices included in the system are already connected to the internal connector of the SCSI adapter. You can connect external devices to the external connector on the SCSI adapter.

**NOTE** The system BIOS will attempt to start the system using a hard disk drive connected to the bootable SCSI adapter in the lowest PCI slot. To start the system using an external SCSI hard disk drive, you must ensure the drive's SCSI adapter is installed lower in slot order than all other bootable SCSI adapters

The Ultra Wide SCSI adapter provides a maximum data transfer rate of 40 MB per second. If you connect a non-Ultra Wide SCSI device to the adapter, data transfer rates are limited to the speed of that device.

The LVD SCSI adapter provides a maximum data transfer rate of 80 MB per second. If you connect a non-LVD SCSI device to the adapter, data transfer rates are limited to the speed of that device.

**CAUTION** Using a non-compliant SCSI-1 device with your system may cause your system to stop working or lead to other unpredictable results.

You can connect up to 15 external SCSI devices to an installed SCSI adapter. However, the number of drives and length of the cables used to connect the drives is limited in most SCSI modes. SCSI-2, Ultra SCSI, and Ultra SCSI impose shorter cable restrictions than SCSI-1.

The total length of the SCSI cabling must not exceed the following:

| <u>Drives</u> | <u>SCSI-1</u> | <u>SCSI-2</u> | <u>Ultra</u> | <u>LVD</u> |
|---------------|---------------|---------------|--------------|------------|
| 1 to 4        | 6 meters      | 3 meters      | 3 meters     | 12 meters  |
| 5 to 7        | 6 meters      | 3 meters      | 1.5 meters   | 12 meters  |
| 8 to 15       | N/A           | N/A           | N/A          | 12 meters  |

**NOTE** If longer Ultra SCSI cable lengths are required, Ultra SCSI mode can be disabled using SYSUTIL, the Setup utility, or the on-board BIOS on the SCSI adapter. However, disabling Ultra SCSI mode reduces the data transfer rate to 20 MB per second on Ultra Wide adapters and to 10 MB per second on Ultra Narrow adapters.

**NOTE** You must count the SCSI adapter as one device.

**NOTE** Make sure the last device on a chain of external SCSI devices has an active SCSI terminator connected to the open SCSI port. All other external SCSI devices must have SCSI termination disabled or removed.

See the SCSI adapter documentation delivered with the system for more detailed information on the SCSI adapter and connecting SCSI devices to it. See *System Reference* for additional details on installing internal peripheral devices.

## Starting the System

The Standby button is on the front left side of the system, behind the door and just below the external drive bay.

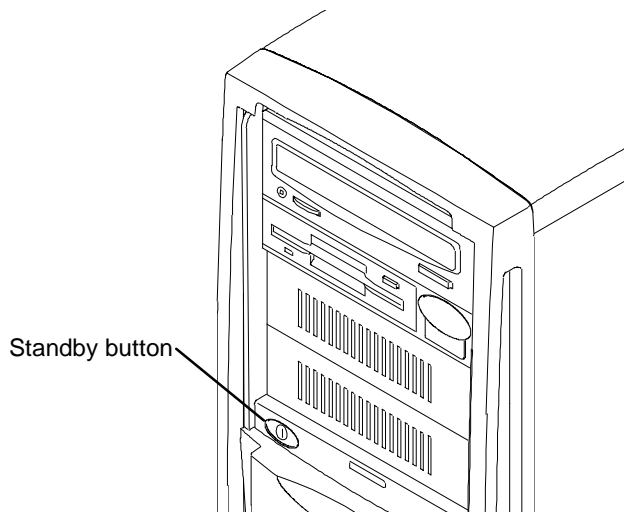

Although the Standby button affects system power management, it is not an “on or off” power switch in the traditional sense. The Standby button is a momentary contact switch, changing system states based upon the length of time the button is pressed. Depending on the operating system running and the system’s current power state, you can use the Standby button to start, suspend, wake up, or power down the system.

See Chapter 2, “Setting Up the Software,” before using the Standby button to start the system for the first time. See Chapter 4, “Operating Notes,” for detailed information on using the Standby button.

## **What’s Next?**

Intergraph Computer Systems installs the operating system through Phase I of the process. From here, continue the installation.

See Chapter 2, “Setting Up the Software,” for instructions on setting up the operating system and associated system software.



---

## 2 Setting Up the Software

Follow the instructions in this chapter to set up the operating system and associated system software on your TDZ 2000 GL2 or ExtremeZ GL2 workstation.

**NOTE** If you are setting up an ExtremeZ workstation for the first time, see the *ExtremeZ Customer Welcome Letter*. The *ExtremeZ Customer Welcome Letter* provides step-by-step instructions for initial setup of an ExtremeZ workstation. Use the information in this chapter only if you have to reinstall the operating system and associated system software on your ExtremeZ workstation.

|  |    |
|--|----|
| Preparing for System Software Setup .....      | 12 |
| Starting Operating System Setup.....           | 14 |
| Finishing System Software Setup .....          | 15 |
| Creating a Repair Disk .....                   | 16 |
| Creating System Software Backup Diskettes..... | 16 |
| What's Next? .....                             | 17 |

## Preparing for System Software Setup

Your system's primary system disk drive and any additional disk drives were formatted and partitioned before shipment. In Explorer or My Computer, you can right-click a disk drive and click Properties to display the drive's partition size and file system format. To view partition and format information for all disk drives, you can use Disk Administrator on a Windows NT system or the **fdisk** command on a Windows 95 or Windows 98 system. See the operating system documentation and Help for more information on these tools.

The operating system and associated system software is pre-installed on the primary hard disk drive. Intergraph Computer Systems installed the following system software:

- ◆ Driver software for the mouse
- ◆ Driver software for the installed video display adapter
- ◆ Driver software for the installed sound adapter
- ◆ Driver software for the installed SCSI adapter (optional)
- ◆ Driver software for the installed networking adapter (optional)
- ◆ Core networking software and the NetBEUI protocol (Windows NT)
- ◆ Service Pack software (Windows NT)
- ◆ Quick-Fix Engineering (QFE) software (fixes for operating system problems or limitations), if needed
- ◆ InterSite software

Intergraph Computer Systems installs the operating system through Phase I of the process. You must follow the operating system Setup process to prepare Microsoft Windows NT, Microsoft Windows 95, or Windows 98 for use. Before you go through Setup, have the following documents available:

- ◆ Microsoft's *Start Here* (for Windows NT) or *Welcome to Windows 95* or *Welcome to Windows 98*.
- ◆ Documents delivered with any expansion cards or additional peripheral devices purchased from Intergraph Computer Systems

---

Get and record the following information:

- ◆ Your name, and the name of your company or organization: \_\_\_\_\_
- ◆ For a system running Windows NT, the CD key from the Windows NT CD case, or the Product ID Number from *Start Here* or the registration card: \_\_\_\_\_
- ◆ For a system running Windows 95 or Windows 98, the Product ID Number from *Welcome to Windows 95* or *Welcome to Windows 98* or the registration card: \_\_\_\_\_
- ◆ A username for a user account: \_\_\_\_\_

If the system is connected to a network, get and record the following general information for your system from your network administrator:

- ◆ Computer name: \_\_\_\_\_
- ◆ Workgroup name (if the system will be part of a workgroup): \_\_\_\_\_
- ◆ Domain name (if the system will be part of a Windows NT domain): \_\_\_\_\_

If the system is connected to a network that uses the Transmission Control Protocol/Internet Protocol (TCP/IP), get and record the following TCP/IP information for your system from your network administrator:

- ◆ Internet Protocol (IP) address: \_\_\_\_\_
- ◆ IP subnet mask: \_\_\_\_\_
- ◆ IP domain name for your network: \_\_\_\_\_
- ◆ IP address for your default gateway: \_\_\_\_\_
- ◆ IP addresses for your network's Domain Name System (DNS) servers: \_\_\_\_\_
- ◆ IP addresses for your network's Windows Internet Name Service (WINS) servers, if any: \_\_\_\_\_

Have several blank, formatted diskettes available to create backup diskettes containing drivers and system software.

The Windows NT delivery media contain software and drivers for both Reduced Instruction Set Computing (RISC)- and Intel-based systems. When installing Windows NT distribution files, make sure you install them from the \i386 directory (the Intel software directory) on the delivery media.

## Starting Operating System Setup

The first time you start the system, it boots to an End-User License Agreement screen. After reviewing and accepting the terms of the agreement, follow the instructions to continue operating system Setup. Take the default settings provided by Setup, except as noted in the following text. You can set up a user account and join a workgroup or domain after you configure the video display, the sound processor, and networking.

### To start the computer and set up the operating system software:

1. Turn on the monitor by pressing its power switch.
2. Open the system's front panel door and press the Standby button, which is described in Chapter 1, "Setting Up the Hardware." The system starts and the EULA screen displays.
3. Enter the Product Identification Number, found on the Certificate of Authenticity included with your operating system documentation.

### NOTE

You must enter the Product Identification Number before you can continue Setup. You cannot complete Setup if you do not enter the number.

4. Follow the instructions displayed on-screen to complete the Setup process.

When setting up the operating system software, remember the following:

- ◆ When prompted to create an Emergency Repair Disk (Windows NT) or a Startup diskette (Windows 95 or Windows 98), do so.
- ◆ If you do not set up a user account during Setup, press ENTER or select OK at the logon dialog to log on to the operating system.

On a system running Windows NT:

- ◆ On a system shipped from the factory without a CD-ROM drive, you can use the C:\i386 directory when prompted for the location of Windows NT Setup files. If you delete the i386 directory from the system's hard disk, you must have access to a Windows NT CD-ROM to use Windows NT Setup files.

On a system running Windows 95 or Windows 98:

- ◆ While operating system files are being copied to the system, you are prompted for the Setup boot diskette, even if the Setup boot diskette is already inserted in the floppy disk drive. Select OK to continue.

Next, you are notified that a CD-ROM driver file (such as OAKCDROM.SYS) could not be found on the Windows 95 or Windows 98 Setup boot diskette. In the dialog that displays, specify that the file should be copied from A:\, and then select OK.

- ◆ The system's hard disk drive contains Windows 95 or Windows 98 Setup files in the C:\WINDOWS\OPTIONS\CABS directory, as compressed .CAB files. When installing network or video display adapter drivers, you can see the CABS directory when prompted for the location of Setup files. If you delete the CABS directory from the system's hard disk, you must have access to a Windows 95 or Windows 98 CD-ROM to use Windows 95 or Windows 98 Setup files.

After you configure the video display, the sound processor, and networking, you can set up a user account and join a workgroup or domain. See Windows NT Help for details on setting up a user account and joining a workgroup or domain.

For more information on operating system Setup, and on using the interface features of the operating system, see the operating system documentation and Help.

## Finishing System Software Setup

After operating system Setup is completed, a *Press to finish setup* icon displays on the operating system desktop. Double-click this icon or select Programs/InterSite/Welcome from the operating system Start menu to display InterSite Welcome.

InterSite Welcome helps you do the following:

- ◆ Create a repair disk for the operating system.
- ◆ Create backup diskettes of device driver software and other system software products.
- ◆ Get the latest driver and other system software from the World Wide Web.
- ◆ Learn about Intergraph Computer Systems customer support.

You should take advantage of the tools provided by InterSite Welcome to ensure that your system is fully ready for use. See InterSite Welcome for more information. Also see the following sections for information on creating a repair disk and creating backup diskettes.

## Creating a Repair Disk

If you did not create an Emergency Repair Disk (Windows NT) or a Startup diskette (Windows 95 or Windows 98) during Setup, use the tools provided by InterSite Welcome to do so. The files on these diskettes can restore the original contents of a damaged operating system Registry (that is, at the time the operating system was installed), along with the standard operating system drivers. You should also update an Emergency Repair Disk or a Startup diskette after you finish configuring the system. See the operating system documentation and Help for more information.

## Creating System Software Backup Diskettes

Backup diskettes for some device driver software and system software products are not delivered with the system. Use InterSite Version Manager, available through InterSite Welcome, to create system software backup diskettes.

Version Manager lets you create backup diskettes containing device driver software and system software products that were installed on the system before shipment, and which are not available on the operating system CD-ROM. You may need these backup diskettes later -- for example, if you have to reinstall a device driver or the operating system.

**WARNING** You must create system software backup diskettes after you set up the system hardware and complete the operating system Setup program. If you do not do this, you may not be able to reinstall critical system software or the operating system if needed.

**NOTE** You may not have to create backup diskettes for all system software. If Version Manager does not list drivers or other system software products, they are available on the operating system software CD-ROM or on backup diskettes delivered with expansion cards.

If the system requires Quick-Fix Engineering (QFE) update software, it is included in the system software available for backup diskette creation. QFE update software contains fixes for operating system problems or limitations, and is only shipped with the system if it is needed. If QFE update software is shipped with the system, you should create a QFE backup diskette for use if you have to reinstall the operating system. See the README.TXT file on the QFE diskette for information on the applicability and installation of QFE update software on your system.

See Version Manager Help for information on creating system software backup diskettes. Visit the Intergraph Computer Systems site on the World Wide Web and vendor bulletin boards for new and updated drivers.

## What's Next?

See Chapter 3, “Configuring the System,” for information on configuring the system for use.





---

## 3 Configuring the System

Follow the instructions in this chapter to configure your TDZ 2000 GL2 or ExtremeZ GL2 workstation for use. This chapter covers items required for basic operation.

|   |    |
|---|----|
| Configuring the Video Display.....                  | 20 |
| Resetting the Video Display Resolution.....         | 20 |
| Correcting Video Display Problems.....              | 21 |
| Configuring Audio.....                              | 22 |
| Configuring Networking .....                        | 22 |
| Configuring a CD-Recorder Drive .....               | 23 |
| Configuring a Tape Drive .....                      | 23 |
| Configuring a Zip or Jaz Drive .....                | 23 |
| Configuring a Modem.....                            | 24 |
| Configuring a PC Card Adapter .....                 | 24 |
| Changing Hard Disk Drive Letters (Windows NT).....  | 25 |
| Changing Virtual Memory Settings (Windows NT) ..... | 25 |
| Getting Operating System Updates.....               | 26 |

## Configuring the Video Display

The first time you start the system, your monitor displays at 1024 x 768 screen resolution. For the system to use the installed video adapter at other display resolutions, you must configure the video display driver as described in this section.

Open Display in the Control Panel to configure the video display driver. Use the Settings tab in the Display Properties dialog box to change the color depth, desktop size, font size, refresh rate, and display type. To determine which video display adapter is installed on your system, click the Display Type button.

See the video display adapter documentation (delivered with the system) and README.TXT files (delivered with the video display driver) for detailed configuration instructions. For information on using the Display Properties or Display Settings dialog, see the operating system documentation and Help.

## Resetting the Video Display Resolution

If the monitor connected to your system does not support a resolution of 1024 x 768, you can reset the video display to another resolution.

### **To reset the video display resolution on a system running Windows NT:**

1. Restart the system.
2. At the boot screen, select the VGA mode option for Windows NT.
3. When the system has started, log on to Windows NT.
4. Right-click the desktop and select Properties. The Display Properties dialog displays.
5. Select a resolution appropriate for your system's monitor.
6. Click Test to test the new video mode, and then click OK.
7. Restart the system.

### **To reset the video display resolution on a system running Windows 95 or Windows 98:**

1. Restart the system.
2. When Starting Windows 95 or Starting Windows 98 displays, press F8. The Startup Menu displays.
3. Select the Safe Mode option, and then press ENTER. The system boots, using the standard VGA resolution (640 x 480).
4. Right-click the desktop and select Properties. The Display Properties dialog displays.

5. Select a resolution appropriate for your system's monitor, and then click OK.
6. Restart the system.

## Correcting Video Display Problems

If the system's video display is black, not synchronized, or distorted after you restart the system, you may have a video configuration problem.

On a system running Windows NT, use the Last Known Good option to return the system to the last known good configuration recorded by Windows NT.

### To use the Windows NT Last Known Good option:

1. Power down and restart the system.
2. Press the space bar at the following prompt:

Press space bar NOW to invoke the Last Known Good Menu

If the Last Known Good option fails, or if Windows 95 or Windows 98 is installed, restart the system in VGA mode to correct the video configuration problem.

### To restart the system in VGA mode:

1. Power down and restart the system.
2. On systems running Windows NT, select the Windows NT Workstation 4.00 [VGA mode] option at the boot screen.

On systems running Windows 95 or Windows 98, press the F8 key when Starting Windows 95... or Starting Windows 98... displays on the screen, then select Safe Mode.

When the operating system desktop displays, right-click the desktop background and select Properties. The Display Properties dialog displays. Check for the following common configuration problems and solutions.

- ◆ A multi-sync monitor is connected to the system, but a multi-sync monitor type is not selected, and the display driver cannot determine this by querying the monitor. Select an appropriate multi-sync monitor type.
- ◆ A selected resolution, depth, or refresh rate is not supported by the multi-sync monitor. Try using different video display settings.
- ◆ The Dual Screen option is selected, but only one video card is detected. Clear the Dual Screen option.
- ◆ A multi-sync monitor is selected, but a monitor with different video timings is connected to the system. Select the appropriate monitor type.

- ◆ The monitor selection doesn't match the multi-sync monitor attached to the system. Restart the system in VGA mode, then select a new monitor.
- ◆ A graphics resolution and color depth has been selected that exceeds installed display memory. Restart the system in VGA mode, then open Display in the Control Panel to reinstall and configure the display driver as described in the video display adapter documentation delivered with the system.

After you've configured the video display, restart the system and select the non-VGA version of the appropriate operating system to use the new configuration.

If problems persist, contact the Customer Response Center for help.

## Configuring Audio

Your system was delivered with an installed Creative Labs Sound Blaster 16 audio card. This is a 16-bit Industry Standard Architecture (ISA) card that contains the system's audio ports and MIDI/game port. If you purchased a multimedia keyboard for your system, see the keyboard documentation for detailed information on connecting it to the system's audio ports.

You can configure the microphone and speaker audio levels by using the Volume Control utility, available as a speaker icon on the Taskbar. For more information on using the sound control programs, see the operating system documentation and Help.

For more information, see the Sound Blaster document delivered with the system.

## Configuring Networking

If you purchased a network adapter with your system, it was installed before shipment. You must configure the operating system to use the network adapter. To do this, you may have to install network driver software and network adapter control software, and then change operating system settings to enable networking. Before you configure networking, make sure that the system has an installed network adapter, and that the network adapter is connected to a network.

To configure networking, open Network in the Control Panel. Follow the instructions in the dialogs to set up the system to use a network. Be sure to set up the appropriate network protocols, such as TCP/IP, for the network to which you are connecting the system.

On a system running Windows NT, after installing network protocols, reinstall the appropriate Windows NT Service Pack software as recommended by Microsoft.

See the documentation for the installed network adapter (delivered with the system) for detailed configuration instructions. See the operating system documentation and Help for information on setting up the system to use a network.

## Configuring a CD-Recorder Drive

If you purchased a CD-Recorder (CD-R) drive with your system, it was installed before shipment. If you purchased the CD-R drive in place of the standard CD-ROM drive, the driver software enabling it to be used as a standard CD-ROM drive was installed before shipment. To use the CD-R drive to record CDs, you must install the CD-R driver software and any associated application software programs.

See the documentation delivered with the CD-R drive for detailed software installation and configuration instructions.

## Configuring a Tape Drive

If you purchased an internal tape drive with your system, it was installed before shipment. On a system running Windows 95 or Windows 98, you may have to install the driver software and any associated applications software programs to use the tape drive. On a system running Windows NT, you can use the Windows NT Backup tool to run the tape drive; select Programs/Administrative Tools/Backup from the Start menu.

See the documentation delivered with the tape drive for configuration instructions. See the device documentation, operating system documentation, and Help for information on using the tape drive.

## Configuring a Zip or Jaz Drive

If you purchased an internal Zip or Jaz drive with your system, it was installed before shipment. To use the drive, you may have to install the driver software and any associated applications software programs.

See the documentation delivered with the Zip or Jaz drive for configuration instructions. See the device documentation, operating system documentation, and Help for information on using the drive.

## Configuring a Modem

If you purchased a modem with your system, you must ensure the BIOS settings and modem jumpers are set appropriately, depending on which operating system and COM port you want to use with the modem.

### To configure the modem:

1. To use the modem with Windows NT, set the COM port jumper pins on the modem to COM2. If that COM port is already in use, set the jumper to use a free COM port.

To use the modem with Windows 95 or Windows 98, set the modem to Plug and Play mode by removing all of the jumpers from the modem.

2. In the PCI/PnP menu in BIOS Setup, set the Boot to PnP Operating System parameter to No if the operating system is Windows NT, or to Yes if the operating system is Windows 95 or Windows 98.
3. The modem requires a specific COM port. You must free system resources for use with the modem in BIOS Setup. Set one of the Onboard Serial Port parameters to Disabled in the Advanced menu in BIOS Setup, according to the following table:

| <u>Modem COM Port</u> | <u>Disable Onboard Serial Port</u> |
|-----------------------|------------------------------------|
| COM1                  | COM1                               |
| COM2                  | COM2                               |
| COM3                  | COM1                               |
| COM4                  | COM2                               |

4. Set the remaining Onboard Serial Port parameter to Auto and restart the system, saving your changes.

If configuring the modem under Windows NT, double-click the modem icon in Control Panel. Use the Install New Modem window to automatically detect the installed modem. Windows NT lists the name of the modem found.

If the listed modem is incorrect, you must install the appropriate driver for your modem, located on the CD-ROM or floppy diskette media that accompanied the modem. Click the Change button, then click the Have Disk button, and insert the driver media into the appropriate drive. Follow the prompts to install the new driver.

## Configuring a PC Card Adapter

If you purchased a PC Card adapter with your system, it was installed before shipment. To use the PC Card adapter, you may have to install the driver software and any associated application software programs.

Depending on your system's configuration, you may have to reserve an interrupt request (IRQ) for a PC Card device inserted in the PC Card adapter. See Chapter 5, "Configuring the BIOS," for information on reserving IRQs in your system's BIOS. See the documentation delivered with the PC Card adapter or device for detailed software installation and configuration instructions.

## Changing Hard Disk Drive Letters (Windows NT)

If you have more than one hard disk drive, you may need to reassign system drive letters. You can also reassign the CD-ROM drive letter, if needed.

### To change drive letters:

1. From the Start menu, click Programs, Administrative Tools, and then Disk Administrator.
2. Select a hard disk drive.
3. From the Tools menu, click Assign Drive Letter.

### NOTE

If you select the current drive or an otherwise locked drive, you must restart the system to complete the drive letter reassignment.

4. Select a new drive letter to assign to the hard disk drive from the list. Click OK, and then click Yes to continue.
5. If necessary, click OK, and then click Yes.
6. Repeat steps 2 through 4 for each hard disk drive letter assignment that you want to change.
7. Click Partition, then click Exit. If necessary, restart the system to complete the drive letter reassignments.

## Changing Virtual Memory Settings (Windows NT)

If you have more than one hard disk drive, you may need to change size and location of your virtual memory page file. See Windows NT Help for more information.

Consider the following before changing page file settings:

- ◆ The size of the page file. If your system is equipped with a large amount of RAM, Setup might create a page file that is unnecessarily large.
- ◆ Drive letter reassignments. If you reassigned your drive letters, you may find it necessary to adjust your page file settings.

**To change the size and location of the virtual memory page file:**

1. From Start, click Settings, and then click Control Panel.
2. Double-click the System icon.
3. Click the Performance tab and then click Change.
4. Click a drive letter in the list, and then type new values in the Initial Size and Maximum Size text boxes.
5. Click Set.
6. Repeat steps 4 and 5 for any additional drives in the list.
7. Click Close, then click OK. An alert box displays.
8. Do one of the following:
  - Click Yes to restart the system with the new settings.
  - Click No to continue with other tasks and use the new settings the next time you restart the system.

## Getting Operating System Updates

Microsoft Service Packs contain the latest improvements and system fixes for Microsoft operating systems. Service Packs are created by Microsoft for post-release support. You can get Service Packs from the Microsoft World Wide Web and FTP sites free of charge.

**CAUTION** If Intergraph Computer Systems provides a Service Pack through the IBBS or with a product or system, it has been certified against Intergraph Computer Systems hardware as described in the announcement of its availability. If you obtain a Service Pack from any other source, be aware that it may not be certified against your Intergraph Computer Systems hardware.



---

## 4 Operating Notes

This chapter contains important, basic information on operating your TDZ 2000 GL2 or ExtremeZ GL2 workstation.

|   |    |
|---|----|
| System Power, Startup, and Shutdown .....                     | 28 |
| Using the Standby Button.....                                 | 28 |
| System Power States.....                                      | 29 |
| Automatic Shutdown Utility (Windows NT).....                  | 30 |
| Starting and Shutting Down the System .....                   | 32 |
| Observing Operating Precautions .....                         | 33 |
| Using the Keyboard .....                                      | 33 |
| Using the Mouse.....  | 35 |
| Using the Floppy Disk Drive.....                              | 35 |
| Using the CD-ROM Drive .....                                  | 36 |
| Using InterSite Programs .....                                | 36 |
| Updating an Emergency Repair Disk or a Startup Diskette ..... | 37 |
| Ensuring PC Card Support and Operation (Windows NT) .....     | 38 |
| Booting from an External SCSI Disk Drive .....                | 38 |
| Using Hardware Security Features .....                        | 39 |
| Finding Serial and Model Numbers.....                         | 40 |
| Cleaning the System .....                                     | 40 |

## System Power, Startup, and Shutdown

When you connect the power cord from the system to an AC power outlet, auxiliary power is applied to the system. This auxiliary power is available for the system to monitor, among other things, the Standby button.

### Using the Standby Button

The Standby button is on the front left side of the system, just below the external drive bay. Open the door to access the Standby button.

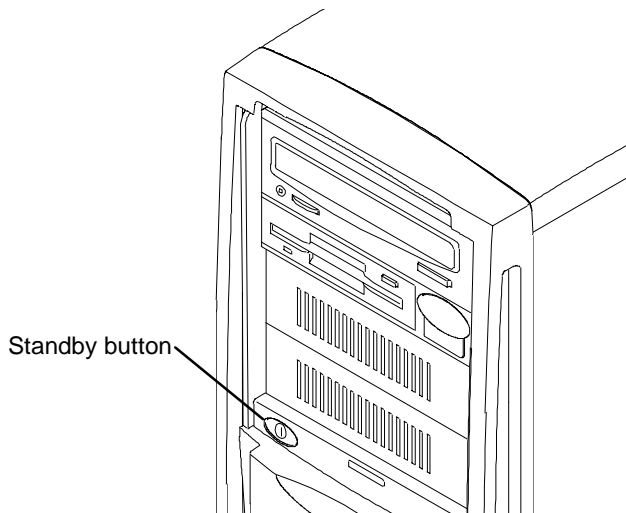

Although the Standby button affects system power management, it is not an “on or off” power switch in the traditional sense. The Standby button is a momentary contact switch, changing system states based upon the length of time the button is pressed. Depending on which operating system is loaded and what the system’s current power state is, you can use the Standby button to start, suspend, wake up, or power down the system.

#### **On a system running Windows 95 or Windows 98 you can:**

- ◆ Start the system from a powered-down state by pressing the Standby button momentarily. The system powers on and loads the operating system.  
To shut down the system, select Shut Down from the Start menu. Select the shutdown option, and then select OK.
- ◆ Suspend the function of the system by pressing the Standby button momentarily while the system is in normal operating mode. The system enters Suspend mode, which lowers the power consumption levels of most system devices.

**NOTE** The AMIBIOS Power Management option *Power Button* must be set to Suspend.

**CAUTION** If the AMIBIOS Power Management option *Power Button* is set to On/Off, the system will immediately power down if the Standby button is pressed. Doing so can cause data loss and file corruption.

To wake the system from Suspend mode, press a key or move the mouse. The system returns to its normal operative state.

See the following table for details on using the Standby button.

| <u>If system is...</u> | <u>Press Standby button...</u> | <u>To...</u>          |
|------------------------|--------------------------------|-----------------------|
| Off (no LEDs on)       | Momentarily (< 1 sec)          | Start the system      |
| Working (green LED on) | Momentarily (< 1 sec)          | Suspend Windows 95/98 |

#### **On a system running Windows NT 4.0 you can:**

- ◆ Start the system from a powered-down state by pressing the Standby button momentarily. The system powers on and loads the operating system.
- ◆ Start the Automatic Shutdown Utility by pressing the Standby button momentarily when the operating system is active.
- ◆ Power down the system by selecting the Shut down option from the Shut Down Start menu option, and then pressing the Standby button when prompted.

**CAUTION** Be sure to select Shut Down from the Start menu, and then select the Shut down option, before powering off the system with the Standby button. Powering off the system simply by using the Standby button can cause data loss and/or file corruption.

See the following table for details on using the Standby button.

| <u>If system is...</u>             | <u>Press Standby button...</u> | <u>To...</u>                         |
|------------------------------------|--------------------------------|--------------------------------------|
| Off (no LEDs on)                   | Momentarily (< 1 sec)          | Start the system                     |
| Working (green LED on)             | Momentarily (< 1 sec)          | Start the Automatic Shutdown Utility |
| Shut down (Restart button visible) | And hold for 4 seconds         | Power down the system                |

## **System Power States**

The advanced power management features of the system help you save energy, prolong system life, and provide for future functionality, such as remote system wake up.

**NOTE** Remember that the system is *always* powered on when it is connected to AC power.

One of the power management features is the implementation of power states. The upper LED on the front panel indicates the system's current power state, as shown in the following table.

| <b>LED</b> | <b>Power State</b> | <b>Description</b> | <b>Explanation</b>  |
|------------|--------------------|--------------------|---|
| Green      | Working            | On                 | System is fully usable; power conservation is on a per-device basis.  |
| Blinking   | Working            | Suspended          | Power consumption is reduced. In Windows 95/98, simply press a key to return the system to the On state. In Windows NT, press and hold the Standby button to power down the computer. |
| Off        | Mechanical Off     | Off                | No power consumption.<br>To return the system to the Working state, press the Standby button to restart the system.   |

## **Automatic Shutdown Utility (Windows NT)**

The Intergraph Automatic Shutdown Utility for Windows NT allows you to select among various shutdown options. This utility provides additional options over the standard shutdown options available from the operating system Start menu. To access Help for this utility, from the operating system Start menu, click Programs, click Automatic Shutdown Utility, and then click Automatic Shutdown Help.

### **Starting the Automatic Shutdown Utility**

Use one of the following methods to start the Automatic Shutdown Utility:

- ◆ Double-click the Automatic Shutdown Utility icon in the taskbar tray.
- ◆ From the operating system Start menu, click Programs, click Automatic Shutdown Utility, and then click Automatic Shutdown Utility.
- ◆ While the system is running, momentarily press the Standby button.

### **Setting Time in the Automatic Shutdown Utility**

By default, the Automatic Shutdown Utility is set for a 10-second delay when starting shutdown. You can use the slider under Time Remaining to set the delay up to 30 seconds. You should not set the delay to less than 5 seconds, to ensure that you have time to stop system shutdown if needed.

## Configuring the Automatic Shutdown Utility

Before you use the Automatic Shutdown Utility, you must configure it. Double-click the Automatic Shutdown Utility icon in the taskbar tray. The Automatic System Shutdown dialog box displays.

Choose a shutdown option and click Apply, then click Start Shutdown. After you start the system again, the utility will use the settings you selected.

Select from the following options in the Automatic Shutdown Utility dialog box:

- ◆ **Shutdown the Computer:** Starts the standard Microsoft Windows shutdown. This option saves any windows settings that you changed, writes information that is currently in memory to the system's hard drive, and prepares the system to power down.

When the system is shut down, press and hold the Standby button for 4 seconds to power down the system. To restart the system, click the Restart button.

- ◆ **Power down the Computer:** Performs an orderly shutdown of the operating system, and then powers down the computer. This option saves any windows settings that you changed, writes information that is currently in memory to the system's hard drive, and then turns off power to the system. This option is similar to the previous option, with the additional convenience of automatically powering off the system.

### NOTE

Intergraph strongly suggests that you use this option to shut down your computer. If you use the Shutdown the Computer option, the system will not power down until you press and hold the Standby button for 4 seconds.

Additionally, you risk inadvertently sending the system into Suspend mode if you hold the Standby button for less than 4 seconds. This mode renders the system unusable, because Windows NT does not support Suspend mode. You must power down the computer before you can restart the system.

- ◆ **Shutdown System and Restart the Computer:** Restarts the system. This option saves any windows settings that you changed, writes information that is currently in memory to the system's hard drive, and powers down and restarts the system.
- ◆ **Close All programs and log on as different user:** Closes any open windows or programs, disconnects the system from the network, and returns the system to the Windows logon prompt. This option prepares the system for use by someone else.

In addition to the above shutdown options, the Automatic Shutdown Utility provides the following features:

- ◆ **Force All Processes to terminate:** Terminates all programs if checked. If this option is not checked, the system displays an End Task dialog for each process that may still be running.

- ◆ **Time Remaining:** Configures the amount of time provided before the selected shutdown option occurs. When the Shutdown utility is started, this timer begins counting down. Press Enter or click the Stop Shutdown button to stop the countdown timer.
- ◆ **Apply:** Makes your selected changes without closing the Shutdown dialog. Use this button to select a different shutdown option, or to change the countdown timer.
- ◆ **Cancel:** Closes the shutdown dialog without saving changes.
- ◆ **Stop Shutdown/Start Shutdown:** Stops or starts the countdown timer. This button toggles between Stop and Start.

**NOTE** If you select an option while the countdown timer is running, the timer stops automatically.

## Starting and Shutting Down the System

After you complete Setup and start the system for the first time, you can start and stop the system as needed.

### **To start the operating system:**

1. Turn on power to the system.
2. On a system running Windows 95 or Windows 98, the operating system starts.

On a system running Windows NT Workstation 4.0, the boot menu displays; select Windows NT to display the logon dialog.

### **To log on to the operating system:**

1. If the logon dialog does not display, press CTRL+ALT+DELETE to display it.
2. Type a username and password into the appropriate boxes.
3. If appropriate, type a domain name.
4. Select OK or press ENTER.

### **To log off, restart, shut down, or power down Windows NT 4.0:**

1. Press the Standby button momentarily. The Automatic System Shutdown window displays, and the Time Remaining countdown starts.
2. Select one of the shutdown options listed in the “Automatic Shutdown Utility” section earlier in this chapter. The Time Remaining countdown halts. Click Start Shutdown.

The chosen shutdown option activates when the Time Remaining countdown expires. The system powers off automatically at the end of the procedure if the Power down the Computer option was chosen.

**To log off, restart, or shut down Windows 95 or Windows 98:**

1. Select Shut Down from the Start menu.
2. Perform one of the following steps, as appropriate:
  - To log off the operating system, select the “Close all programs” option (if given), and then select OK.
  - To restart the system, select the restart option, and then select OK.
  - To shut down the system, select the shutdown option, and then select OK.

After shutting down Windows 95 or Windows 98, the system powers off automatically.

## Observing Operating Precautions

Observe the following precautions when operating the system:

- ◆ When restarting the system, use the operating system controls instead of turning the power switch off and on. Use the power switch only when instructed, or as the last alternative for restarting the system.
- ◆ Never turn off power to the base unit when the disk access LED is lit.
- ◆ After turning off power to the base unit, wait at least 30 seconds before turning the power on again.
- ◆ Run virus scan software periodically to ensure that your system’s files and programs are not corrupted.

## Using the Keyboard

The system’s keyboard includes the following features:

- ◆ PS/2 compatibility.
- ◆ 104 standard keys.
- ◆ Function keys (F1 through F12) for special functions used by application programs.
- ◆ Windows keys at the bottom, for use with the Windows NT and Windows 95 operating system. Pressing either Windows Logo key displays the operating system Start menu. Pressing the Application Logo key displays an application-specific pop-up menu.
- ◆ Arrow keys for moving the cursor up, down, right, and left on the screen.
- ◆ Numeric keys in a numeric keypad.

Some keyboard keys have special functions, as follows:

| <b>Key</b>  | <b>Function</b>  |
|-------------|--|
| ESC         | Usually assigned to an application-specific function; often used to exit.      |
| PRINT SCRN  | Depending on the application in use, prints the displayed screen to a printer. |
| SCROLL LOCK | Prevents the screen from scrolling.  |
| PAUSE       | Temporarily suspends screen scrolling or some operations.                      |
| CAPS LOCK   | Types all letters as capitals.   |
| NUM LOCK    | Activates the numeric keypad.  |
| CTRL        | Used with another key for application-specific functions.                      |
| ALT         | Used with another key for application-specific functions.                      |
| DELETE      | Deletes characters.  |

You can use the Windows Logo keys in combination with other keys to perform certain operating system functions, as follows:

| <b>Windows Logo Key Combination</b> | <b>Action</b>                                 |
|-------------------------------------|---|
| Windows Logo + F1                   | Display a pop-up menu for the selected object |
| Windows Logo + TAB                  | Activate the next button on the taskbar       |
| Windows Logo + E                    | Run Explorer                                  |
| Windows Logo + F                    | Run Find Document                             |
| Windows Logo + CTRL + F             | Run Find Computer                             |
| Windows Logo + M                    | Minimize all                                  |
| SHIFT + Windows Logo + M            | Undo Minimize all                             |
| Windows Logo + R                    | Display the Run dialog                        |
| Windows Logo + PAUSE/BREAK          | Perform a system function                     |

If your system was delivered with a multimedia keyboard, it contains other controls and ports for use with your system's multimedia capabilities. See the documentation delivered with the multimedia keyboard for more information.



## Using the Mouse

The system's mouse is a PS/2-compatible tracking device that controls the movement and positioning of the pointer (or cursor) displayed on the screen in a graphical display environment. The basic techniques for using the mouse are as follows:

| <b>Action</b> | <b>Description</b>   |
|---------------|--|
| Point         | Move the mouse to point to your selection on the screen.   |
| Click         | Press and release the left mouse button once.  |
| Double-click  | Press and release the left mouse button twice.   |
| Drag          | Press and hold the left mouse button, then move the mouse. Release the button when you finish dragging your selection to a new location. |
| Right click   | Press and release the right mouse button once.   |

**NOTE** The double-click speed is timed. If you double-click too slowly, the system responds as if you clicked twice. You can adjust the double-click speed using the operating system's Mouse application.

To use the mouse, make sure it is properly connected to the system. Place the mouse on a clean, flat surface, such as a desktop or a mouse pad. Move the mouse across the flat surface to move the pointer across the screen.

## Using the Floppy Disk Drive

The system's floppy disk drive occupies a 3.5-inch peripheral device bay, and is accessible through a 3.5-inch slot on the front of the base unit. The drive accepts standard 3.5-inch 720 KB and 1.44 MB diskettes.

Follow these guidelines to use the floppy disk drive:

- ◆ To insert a diskette into the drive, position the diskette so the arrow embossed on the diskette faces up. Slide the diskette into the floppy disk slot and through the drive door, and push it into the drive until it clicks into place and the eject button next to the slot pops out.
- ◆ Before removing a diskette, ensure the drive LED is not lit. The LED lights green to indicate floppy disk drive activity.
- ◆ Remove the diskette by pushing the eject button adjacent to the floppy disk slot, and then pulling the diskette out of the drive.
- ◆ To protect the data on a diskette from being overwritten or erased, slide the write-protect tab on the diskette toward the diskette edge until it snaps into place. When the write-

protect opening is uncovered, the disk can be read from, but not written to. To write data to a diskette, ensure the write-protect opening is covered.

## Using the CD-ROM Drive

The system's CD-ROM drive occupies a 5.25-inch peripheral device bay, and is accessible through a tray or a slot at the front of the base unit. The CD-ROM drive is an Enhanced Integrated Device Electronics (EIDE) device that features MPC-3 compatibility and multi-session Photo CD support. The drive also supports software ejection of discs and has an external amplified headphone jack.

If you purchased a DVD-ROM drive to replace the standard CD-ROM drive, you can use it as a standard CD-ROM drive.

To use the CD-ROM drive:

- ◆ To insert a disc into a tray-load CD-ROM drive, press the eject button to extend the tray. Place the disc, printed side up, in the tray and press the eject button to load the disc.
- ◆ To insert a disc into a slot-load CD-ROM drive, insert the disc, printed side up, into the slot.
- ◆ To eject a disc from the CD-ROM drive, press the eject button adjacent to the CD-ROM drive slot or tray.

### NOTE

The software application being used may prevent the compact disc from ejecting. If so, run the proper application command to eject the compact disc.

- ◆ The media player application program(s) included with the operating system allows you to listen to audio compact discs. Insert an audio compact disc, printed side up, into the CD-ROM drive and start the media player application. Adjust the volume using the operating system's sound control programs.

If you purchased a DVD-ROM drive, you can also use it to play DVD discs. See the DVD-ROM documentation delivered with the system for more information.

## Using InterSite Programs

All systems ship with the following InterSite programs:

- ◆ InterSite Welcome, which provides tools to ensure that your system is fully ready for use. See InterSite Welcome for more information.
- ◆ InterSite Version Manager, a tool for creating system software backup diskettes, and for updating device drivers and other system software products installed on the system.

See Chapter 2, “Setting Up the Software,” for more information on these programs.

Systems running Windows NT ship with the following InterSite programs:

- ◆ InterSite Manager, the common starting point for all the InterSite products. This utility integrates InterSite components by centralizing them in an easy-to-use point-and-click display. You can familiarize yourself with an InterSite component before invoking it, by reading its description, conveniently placed by its launch button.
- ◆ InterSite DMI Console, which gives easy access to the system’s status and configuration information. The Console is based on the Desktop Management Interface (DMI), through a window containing a graphical information tree view pane, a service provider component information pane, and a message pane. DMI Console works with the Desktop Management Interface (DMI), a technology standard that enables the effective management of personal computers (PCs).
- ◆ InterSite Watchdog, a system monitoring tool with remote monitoring capabilities. You can install Watchdog on a system running the Windows NT, and use it to monitor workstations and servers also running Windows NT.

**NOTE**

Only systems with ECC memory come with the InterSite ECC Memory Monitor.

- ◆ InterSite Diskkeeper Lite, which manually defragments Windows NT file systems, thus restoring performance. By using InterSite Diskkeeper Lite, disk fragmentation can be kept to a minimum, improving file creation and access times.
- ◆ InterSite SmartDrive, a kernel-level driver that supports self-monitoring, analysis, and reporting technology. SmartDrive system compliance is displayed via a tab on the Hardware Monitor. Each system disk is listed on the tab, along with its serial number and Smart System compliance information. For more information, refer to InterSite Hardware Monitor's online help.

From the operating system Start menu, go to Programs/InterSite to find the InterSite programs on your system. See the online Help for each InterSite program for more information on how to use the program.

## Updating an Emergency Repair Disk or a Startup Diskette

You may have created an Emergency Repair Disk (Windows NT) or a Startup diskette (Windows 95 or Windows 98) during first-time startup, or through InterSite Welcome. If you did not, you should create the appropriate diskette after you finish configuring the system. If you did, you should update it any time you change the configuration of the system. The files on the Windows NT Emergency Repair Disk can restore the original contents of a damaged operating system Registry (that is, at the time the operating system

was installed), along with the standard operating system drivers. Use the Startup diskette to start the system in the event you have trouble starting Windows 95 or Windows 98.

See the operating system documentation for more information.

## Ensuring PC Card Support and Operation (Windows NT)

The optional PC Card adapter is used with devices based on standards developed by the Personal Computer Memory Card International Association (PCMCIA). See the operating system documentation and Help for more information on PC Card device support.

To ensure proper operation of PC Card devices with a system running Windows NT, make sure the device drivers that control PC Card device operation are set to start correctly. Do this before using the PC Card adapter, or anomalous behavior may result. Go to Devices in the Control Panel and do the following:

- ◆ Set the Pcmcia device to start as a Boot device.
- ◆ Set the Atdisk device to start as a System device.

Restart the system after making these changes. As the system restarts, run BIOS Setup and make the following BIOS changes to ensure proper operation of specific PC Card devices:

- ◆ For a PC Card hard disk device (ATA or AT type), go to Advanced/PCI-PnP Configuration/PCI-PnP IRQ Exclusion and reserve IRQ 9.
- ◆ For a PC Card modem, go to Advanced/Integrated Ports and disable serial port B.

See *System Setup* for more information on using the BIOS Setup program.

To use a PC Card modem, take these additional steps:

1. Insert the PC Card modem into the PC Card adapter, and then restart the system.
2. In Devices/Modems in the Control Panel, use the Modem Wizard to auto-detect the PC Card modem. Follow the directions displayed to select the proper driver software.

## Booting from an External SCSI Disk Drive

If your system has access to an IDE or EIDE drive, it will attempt to boot from the drive. If you install a SCSI adapter in your system, you can boot the system from an external SCSI disk drive if you take the following steps.

**To boot from an external SCSI disk drive:**

1. Disconnect any IDE or EIDE disk drives from the primary and secondary IDE controllers. The system's BIOS will not accept a mixture of SCSI and IDE/EIDE devices if the boot device is a SCSI disk drive.
2. Disconnect the CD-ROM drive from the secondary IDE controller and reconnect it to the primary IDE controller.
3. Configure the BIOS for a SCSI system.

**NOTE**

If you have more than one bootable SCSI adapter installed, the system BIOS will attempt to start the system using a hard disk drive connected to the bootable SCSI adapter in the lowest PCI slot. To start the system using a specific external SCSI hard disk drive, you must ensure the drive's SCSI adapter is installed physically lower in slot order than all other bootable SCSI adapters.

See Chapter 5, "Configuring the BIOS," for BIOS information. See Chapter 1, "Setting Up the Hardware," for device connection information.

If the CD-ROM drive is not visible in Windows NT after booting from a SCSI disk drive, make sure that the AT Attachment Packet Interface (ATAPI) device is enabled.

**To enable the ATAPI device in Windows NT:**

1. Open Devices in the Control Panel. The Devices dialog displays.
2. Highlight atapi in the Device list; then select Startup. The Device dialog displays.
3. Under Startup Type, select Boot; then select OK.
4. In the Devices dialog, select Close.

## Using Hardware Security Features

The system provides you with several security features designed to help prevent unauthorized tampering with the internal components.

A security tab is located at the top left of the chassis under the top cover. You can place a small padlock or a security seal in the hole on the tab to prevent removal of the left side panel.

A tamper-indicating Factory Quality Seal is affixed to the main chassis and left side panel security tab. The seal is your assurance that the unit has not been opened since it left the factory. When removed, the word "VOID" appears on the seal. Removing the seal does not void your warranty.

## Finding Serial and Model Numbers

The system's serial number and model number are on a label affixed on the right side (as viewed from the front).

## Cleaning the System

**CAUTION** Turn off power to the system before cleaning the exterior surfaces, the mouse, or the keyboard. Do not clean the CD-ROM drive.

Follow these guidelines for cleaning the system:

| <b>Item</b>       | <b>How To Clean</b>  |
|-------------------|--|
| Mouse             | On the bottom of the mouse, a retaining ring holds the tracking ball in place. Remove the retaining ring and turn the mouse over; the tracking ball will fall out. Blow gently into the opening. Clean the tracking ball and rollers with a cotton swab and alcohol. Replace the tracking ball and the retaining ring. |
| Keyboard          | Dust with a dry cloth. Aerosol cleaners are commercially available to remove the dust between the keys of the keyboard. Never allow moisture on the keyboard or the surface beneath the keys.  |
| Exterior Surfaces | Clean the exterior surfaces of the base unit and the monitor screen with a mild cleaning detergent and a clean cloth.  |

---

# 5 Configuring the BIOS

This chapter documents the setup parameters of the system's basic input/output system (BIOS).

|  |    |
|--|----|
| Introduction .....                               | 42 |
| Standard CMOS Setup .....                        | 43 |
| Advanced CMOS Setup .....                        | 44 |
| Advanced Chipset Setup .....                     | 48 |
| Power Management Setup .....                     | 52 |
| PCI/Plug and Play Setup .....                    | 55 |
| Peripheral Setup .....                           | 57 |
| Auto-Detect Hard Disks .....                     | 59 |
| Change Supervisor Password .....                 | 59 |
| Change User Password .....                       | 59 |
| Change Language Setting .....                    | 59 |
| Auto Configuration with Optimal Settings .....   | 59 |
| Auto Configuration with Fail-Safe Settings ..... | 60 |
| Save Settings and Exit .....                     | 60 |
| Exit Without Saving .....                        | 60 |
| Updating the System BIOS .....                   | 60 |

## Introduction

The system's basic input/output system (BIOS) records basic system operating parameters, such as the amount of memory, the boot sequence, and the type of video display. The operating parameters are set in the BIOS before shipment. The BIOS is stored in flash erasable-programmable memory (EPROM) on the system board, and reads the system parameters in the system's complementary metal-oxide semiconductor (CMOS) random-access memory (RAM). When you power off the system, a lithium battery provides power to CMOS RAM to retain the operating parameters. Each time you power on the system, the BIOS uses stored parameters to configure the system.

The BIOS Setup program, which is also stored in the flash EPROM on the system board, allows you to manually change the system operating parameters. The BIOS Setup program can also be accessed by the user during the system's power-on self test (POST).

To run the BIOS Setup program, press `DELETE` at the appropriate time during system boot.

BIOS Setup contains the following menus:

| <b>Types of Setup</b> | <b>Description</b>  |
|-----------------------|---|
| Standard CMOS         | Sets time, date, hard disk type, types of floppy drives, and boot sector virus protection.  |
| Advanced CMOS         | Sets system boot sequence, disk access, NUM-LOCK key status, PS/2 mouse support, primary display, password, and other parameters. |
| Advanced Chipset      | Sets chipset-specific options and features.   |
| Power Management      | Controls power conservation options.  |
| PCI/Plug and Play     | Sets options related to the PCI bus and Plug and Play options.  |
| Peripheral            | Controls input/output (I/O) controller-related options.   |



# Standard CMOS Setup

## Date (mm/dd/yyyy), Time (hh/mm/ss)

To set the system date and time, use **TAB** to move the prompt and select a field (hours, minutes, or seconds). Use the plus key (+) to increase the number; use the minus key (-) to decrease the number. To select a previous field, press **SHIFT+TAB**.

## Floppy Drive A: and B:

Move the cursor to these fields via **↑** and **↓** and select the floppy type. The settings are 360 KB 5¼ inch, 1.2 MB 5¼ inch, 720 KB 3½ inch, 1.44 MB 3½ inch, and 2.88 MB 3½ inch.

## Primary (Master/Slave), Secondary (Master/Slave)

Select these options to configure the drive named in the option. Select **Auto** to let BIOS automatically configure the drive. A list of drive parameters appears.

## Entering Drive Parameters

You can also enter the hard disk drive parameters. The drive parameters are:

| <b>Parameter</b> | <b>Description</b>   |
|------------------|--|
| Type             | The number for a drive with certain identification parameters.   |
| Size             | The formatted capacity of the drive is the number of heads times the number of cylinders times the number of sectors per track times 512 (bytes per sector).   |
| Cyln             | The number of cylinders in the disk drive.   |
| Head             | The number of heads.   |
| WPcom            | The actual physical size of a sector gets progressively smaller as the track diameter diminishes. Yet each sector must still hold 512 bytes. Write precompensation circuitry on the hard disk compensates for the physical difference in sector size by boosting the write current for sectors on inner tracks. This parameter is the track number on the disk surface where write precompensation begins. |
| LBA Mode         | Toggles Logical Block Addressing mode.   |
| Block Mode       | Toggles multi-sector transfer mode.  |

| <u>Parameter</u> | <u>Description</u>   |
|------------------|--|
| PIO Mode         | Sets the transfer speed. The slowest speed is PIO Mode 0; the fastest speed is PIO Mode 5, or Ultra DMA mode.  |
| 32 Bit Mode      | Toggles 32 bit transfer mode.  |
| Sectors          | The number of sectors per cylinder. MFM drives have 17 sectors per track. RLL drives have 26 sectors per track. ESDI drives have 34 sectors per track. SCSI and IDE drives have even more sectors per track. |

## Boot Sector Virus Protection

This parameter toggles virus protection for the boot sector of the system drive. The Optimal default setting is Enabled.

## Advanced CMOS Setup

### Quick Boot

Set this option to Enabled to instruct the BIOS to boot quickly when the computer is powered on. This option replaces the old Above 1 MB Memory Test Advanced Setup option. The settings are:

| <u>Setting</u> | <u>Description</u>  |
|----------------|---|
| Disabled       | The BIOS tests all system memory. The BIOS waits up to 40 seconds for a READY signal from the IDE hard disk drive. The BIOS waits for .5 seconds after sending a RESET signal to the IDE drive to allow the IDE drive time to get ready again. The BIOS checks for a DELETE key press and runs BIOS Setup if the key has been pressed.  |
| Enabled        | The BIOS does not test system memory above 1 MB. The BIOS does not wait up to 40 seconds for a READY signal from the IDE hard disk drive. If a READY signal is not received immediately from the IDE drive, The BIOS does not configure that drive. The BIOS does not wait for .5 seconds after sending a RESET signal to the IDE drive to allow the IDE drive time to get ready again. |

The Optimal default setting is Enabled and the Fail-Safe default setting is Disabled.

---

## **Pri (Master/Slave) ARMD Emulated as Sec (Master/Slave) ARMD Emulated as**

The settings are Auto, Floppy, and Hard Disk. The Optimal default setting is Auto.

### **1st Boot Device**

This option sets the type of device for the second boot drives that the BIOS attempts to boot from after POST completes. The settings are Disabled, 1st IDE-HDD, 2nd IDE-HDD, 3rd IDE-HDD, 4th IDE-HDD, Floppy, ARMD-FDD, ARMD-HDD, Atapi CD-ROM, SCSI, and Network. The Optimal default setting is Floppy.

### **2nd Boot Device**

This option sets the type of device for the second boot drives that the BIOS attempts to boot from after POST completes. The settings are Disabled, 1st IDE-HDD, 2nd IDE-HDD, 3rd IDE-HDD, 4th IDE-HDD, Floppy, ARMD-FDD, ARMD-HDD, Atapi CD-ROM, and SCSI. The Optimal default setting is 1st IDE-HDD.

### **3rd Boot Device**

This option sets the type of device for the second boot drives that the BIOS attempts to boot from after POST completes. The settings are Disabled, 1st IDE-HDD, 2nd IDE-HDD, 3rd IDE-HDD, 4th IDE-HDD, Floppy, ARMD-FDD, ARMD-HDD, and Atapi CD-ROM. The Optimal default setting is Atapi CD-ROM.

### **Try Other Boot Devices**

The Optimal default setting is Yes.

### **Initial Display Mode**

The Optimal default setting is Silent; the other setting is BIOS.

### **Floppy Access Control**

The Optimal default setting is Read-Write.

### **Hard Disk Access Control**

The Optimal default setting is Read-Write.

## **S.M.A.R.T. For Hard Disks**

Set this option to Enabled to permit the BIOS to use the SMART (System Management and Reporting Technologies) protocol for reporting server system information over a network. The settings are Enabled and Disabled. The Optimal default setting is Enabled.

## **BootUp Num Lock**

Set this option to Off to turn the Num Lock key off when the computer is booted so you can use the arrow keys on both the numeric keypad and the keyboard. The settings are On and Off. The default setting is On.

## **PS/2 Mouse Support**

Set this option to Enabled to enable the BIOS support for a PS/2-type mouse. Pins 2-3 of the PS/2 Mouse Selector jumper on the motherboard must be jumpered to enable PS/2 mouse support. The Optimal default setting is Enabled.

## **Primary Display**

This option configures the type of monitor attached to the computer. The settings are Absent, VGA/EGA, CGA40x25, CGA80x25, and Mono. The Optimal default setting is VGA/EGA.

## **Password Check**

This option enables password checking every time the system boots and when you run BIOS Setup. If Always is chosen, a user password prompt appears every time the computer is turned on. If Setup is chosen, the password prompt appears if the BIOS is executed and a password is defined. The Optimal default is Setup.

## **Boot To OS/2**

Set this option to Yes if running the OS/2 operating system and using more than 64 MB of system memory on the motherboard. The settings are Yes and No. The Optimal default setting is No.

## **Internal Cache**

This option sets the type of caching algorithm used by the L1 internal cache memory on the CPU. The settings are Disabled, WriteThru, and WriteBack. The Optimal default setting is WriteBack.

## System BIOS Cacheable

When set to Enabled, the contents of the F0000h system memory segment can be read from and written to cache memory. The contents of this memory segment are always copied from the BIOS ROM to system RAM for faster execution. The settings are Enabled and Disabled. The Optimal default setting is Enabled.

## Cache Bus ECC

The Optimal default setting is Enabled.

## Default Primary Video

This option determines which video card in a multi-video card system is the primary video display. The Optimal default setting is AGP; the other setting is PCI.

## MPS Revision

The Optimal default setting is 1.1; the other setting is 1.4.

## C000/C400,16K Shadow

These options specify how the 32 KB of video ROM at C0000h and C400h are treated. The settings are:

| <u>Setting</u> | <u>Description</u>  |
|----------------|---|
| Disabled       | The contents of the video ROM are not copied to RAM.  |
| Enabled        | The contents of the video ROM area from C0000h - C7FFFh are copied (shadowed) from ROM to RAM for faster execution.                 |
| Cached         | The contents of the video ROM area from C0000h - C7FFFh are copied from ROM to RAM and can be written to or read from cache memory. |

The Optimal default setting is Cached.

## C800/CC00/Dx00,16K Shadow

These options enable shadowing of the contents of the ROM area named in the option. The ROM area not used by ISA adapter cards is allocated to PCI adapter cards. The settings are:

| <u>Setting</u> | <u>Description</u>                                   |
|----------------|--|
| Disabled       | The contents of the video ROM are not copied to RAM. |

| <b>Setting</b> | <b>Description</b>  |
|----------------|---|
| Cached         | The contents of the video ROM area from C0000h - C7FFFh are copied from ROM to RAM and can be written to or read from cache memory. |
| Enabled        | The contents of the video ROM area from C0000h - C7FFFh are copied (shadowed) from ROM to RAM for faster execution.                 |

The Optimal default setting is Disabled.

## **Advanced Chipset Setup**

### **USB Function**

Set this option to Enabled to enable USB (Universal Serial Bus) support. The settings are Enabled and Disabled. The Optimal default setting is Disabled.

### **USB KB/Mouse Legacy Support**

Set this option to Keyb+Mouse to enable support for older keyboards and mouse devices. The settings are Disabled, Keyboard, Auto, and Keyb+Mouse. The Optimal default setting is Disabled.

### **Port 64/60 Emulation**

The Optimal default setting is Disabled.

### **SERR#**

The Optimal default setting is Disabled.

### **PERR#**

The Optimal default setting is Disabled.

### **WSC# Handshake**

The Optimal default setting is Enabled.

## USWC Write Post

Set this option to Enabled to allow write operations from USWC memory to be posted. The settings are Enabled and Disabled. The Optimal default setting is Enabled.

## Master Latency Timer (Clks)

The settings are Disabled, 32, 64, 96, 128, 160, 192, and 224. The Optimal default setting is 64.

## Multi-Trans Timer (Clks)

The settings are Disabled, 32, 64, 96, 128, 160, 192, and 224. The Optimal default setting is 32.

## PCI1 to PCI0 Access

The Optimal default setting is Disabled.

## Method of Memory Detection

Settings are Auto & SPD and Auto Only. The Optimal default setting is Auto & SPD.

## DRAM Integrity Mode

The settings are None, EC, and ECC Hardware. The Optimal default setting is ECC Hardware.

## DRAM Refresh Rate

The settings are 15.6 us, 31.2 us, 62.4 us, 124.8 us, and 249.6 us. The Optimal default setting is 15.6 us.

## Memory Hole

This option specifies the location of an area of memory that cannot be addressed on the ISA bus. The settings are Disabled, 15 MB-16 MB, and 512KB-640KB. The Optimal default setting is Disabled.

## **SDRAM RAS# to CAS# delay**

The settings are 3 SCLKs, 2 SCLKs, and Auto. The Optimal default setting is 3 SCLKs.

## **SDRAM RAS# Precharge**

The settings are 3 SCLKs, 2 SCLKs, and Auto. The Optimal default setting is 3 SCLKs.

## **Power Down SDRAM**

The Optimal default setting is Enabled.

## **ACPI Control Register**

The Optimal default setting is Disabled.

## **Gated Clock**

The Optimal default setting is Disabled.

## **Graphics Aperture Size**

The settings are 4 MB, 8 MB, 16 MB, 32 MB, 64 MB, 128 MB, and 256 MB. The Optimal default setting is 64 MB.

## **Search for MDA Resources**

The Optimal default setting is Yes.

## **AGP Mlti-Trans Timer (AGP Clks)**

The settings are Disabled, 32, 64, 96, 128, 160, 192, and 224. The Optimal default setting is 32.

## **AGP Low-Priority Timer (AGP Clks)**

The settings are Disabled, 16, 32, 48, 64, 80, 96, 112, 128, 144, 176, 192, 208, 224, and 240. The Optimal default setting is 16.



---

## **AGP SERR**

The Optimal default setting is Disabled.

## **AGP Parity Error Response**

The Optimal default setting is Disabled.

## **8bit I/O Recovery Time**

The Optimal default setting is Disabled.

## **16bit I/O Recovery Time**

The Optimal default setting is Disabled.

## **PIIX4 SERR#**

The Optimal default setting is Disabled.

## **USB Passive Release**

Set this option to Enabled to enable passive release for USB. The Optimal default setting is Enabled.

## **PIIX4 Passive Release**

The Optimal default setting is Enabled.

## **PIIX4 Delayed Transaction**

The Optimal default setting is Disabled.

## **TypeF DMA Buffer (Control1/Control2)**

These options specify the DMA channel where TypeF buffer control is implemented. The Optimal default setting is Disabled.

## DMA-# Type

The settings are Normal ISA, PC/PCI, and Distributed. The Optimal default setting is Normal ISA.

## CPU Bus Frequency

The settings are Auto, 66.8 MHz, 68.5 MHz, 75 MHz, 83.3 MHz, 100 MHz, 103 MHz, and 112 MHz. The Optimal default setting is Auto.

## Power Management Setup

The BIOS Setup options described in this section are selected by choosing Power Management Setup from the BIOS Setup main menu.

### ACPI Aware O/S

The Optimal setting is No.

### Power Management/APM

Set this option to Disabled to disable the chipset power management and APM (Advanced Power Management) features. The Optimal setting is Enabled.

### Power Button Function

The Optimal default setting is On/Off; the other setting is Suspend.

### Green PC Monitor Power State

This option specifies the power state that the green PC-compliant video monitor enters when the BIOS places it in a power saving state after the specified period of display inactivity has expired. The settings are Off, Standby, and Suspend. The Optimal default setting is Suspend.

### Video Power Down Mode

This option specifies the power state that the video subsystem enters when the BIOS places it in a power saving state after the specified period of display inactivity has expired. The settings are Standby, Suspend and Disabled. The Optimal default setting is Suspend.

---

## Hard Disk Power Down Mode

This option specifies the power conserving state that the hard disk drive enters after the specified period of hard drive inactivity has expired. The settings are Disabled, Standby, and Suspend. The Optimal default setting is Suspend.

## Hard Disk Timeout (Minute)

This option specifies the length of a period of hard disk drive inactivity. When this length of time expires, the computer enters power-conserving state specified in the Hard Disk Power Down Mode option. The settings are Disabled and 1 - 15 minutes. The Optimal default setting is Disabled.

## Power Saving Type

The settings are POS, Sleep, Stop Clock, and Deep Sleep. The Optimal default setting is Sleep.

## Standby / Suspend Timer Unit

The settings are 4 milliseconds, 4 seconds, 32 seconds, and 4 minutes. The Optimal default setting is 4 minutes.

## Standby Time Out

This option specifies the length of a period of system inactivity while in Full On state. When this length of time expires, the computer enters Standby power state. The settings are Disabled and 4 - 508 minutes. The Optimal default setting is Disabled.

## Suspend Time Out

This option specifies the length of a period of system inactivity while in Standby state. When this length of time expires, the computer enters Suspend power state. The settings are Disabled and 4 - 508 minutes. The Optimal default setting is Disabled.

## Slow Clock Ratio

This option specifies the speed at which the system clock runs in the Standby Mode power saving state. The settings are expressed as a percentage of the normal CPU clock speed. The settings are 0 - 12.5, 12.5 - 25, 25 - 37.5, 37.5 - 50, 50 - 62.5, 62.5 - 75, and 75 - 87.5. The Optimal default setting is 50 - 62.5.

## Display Activity

When set to Monitor, this option enables event monitoring on the video display. If set to Monitor and the computer is in a power saving state, the BIOS watches for display activity. The computer enters the Full On state if any activity occurs. The BIOS reloads the Standby and Suspend timeout timers if display activity occurs. The settings are Monitor and Ignore. The Optimal default setting is Ignore.

## Device 6 (Serial port 1), Device 7 (Serial port 2)

### Device 8 (Parallel port)

### Device 5 (Floppy disk)

### Device 0 (Primary master IDE), Device 1 (Primary slave IDE)

### Device 2 (Secondary master IDE), Device 3 (Secondary slave IDE)

When set to Monitor, these options enable event monitoring of the specified hardware device. If set to Monitor and the computer is in a power saving state, the BIOS watches for activity on the specified device. The computer enters the Full On state if any activity occurs. The BIOS reloads the Standby and Suspend timeout timers if activity occurs on the specified IRQ line.

The settings for each option are Monitor and Ignore. The Optimal default setting is Ignore.

## LAN Wake-Up

The Optimal default setting is Disabled.

## PC98 Power LED

The Optimal default setting is Disabled.

## FAN OFF at Suspend

The Optimal default setting is Enabled.

## RTC Wake-Up

The Optimal default setting is Disabled.

### Hour

The Optimal default setting is N/A.

## Minute

The Optimal default setting is N/A.

# PCI/Plug and Play Setup

## Plug and Play Aware O/S

Set this option to Yes to inform the BIOS that the operating system can handle plug and Play (PnP) devices. The settings are No and Yes. The Optimal default setting is No.

## PCI Latency Timer (PCI Clocks)

This option specifies the latency timings (in PCI clocks) for PCI devices installed in the PCI expansion slots. The settings are 32, 64, 96, 128, 160, 192, 224, and 248. The Optimal default setting is 64.

## PCI VGA Palette Snoop

When this option is set to Enabled, multiple VGA devices operating on different buses can handle data from the CPU on each set of palette registers on every video device. Bit 5 of the command register in the PCI device configuration space is the VGA Palette Snoop bit (0 is disabled). For example: if there are two VGA devices in the computer (one PCI and one ISA) and:

| <b>VGA Palette Snoop Bit</b> | <b>Action</b>   |
|------------------------------|---|
| Disabled                     | Data read and written by the CPU is only directed to the PCI VGA device's palette registers.  |
| Enabled                      | Data read and written by the CPU is directed to the both the PCI VGA device's palette registers and the ISA VGA device palette registers, permitting the palette registers of both devices to be identical. |

This option must be set to Enabled if any ISA adapter card installed in the system requires VGA palette snooping. The Optimal default setting is Disabled.

## Allocate IRQ to PCI VGA

The Optimal default setting is No.

## PCI IDE BusMaster

Set this option to Enabled to specify that the IDE controller on the PCI bus has bus mastering capability. The settings are Disabled and Enabled. The Optimal default setting is Enabled.

## Offboard PCI IDE Card

This option specifies if an offboard PCI IDE controller adapter card is used in the computer. You must also specify the PCI expansion slot on the motherboard where the offboard PCI IDE controller card is installed. The settings are Auto, Slot1, Slot2, Slot3, Slot4, Slot5, and Slot6. If Auto is selected, the BIOS automatically determines the correct setting. The Optimal default setting is Auto.

## PCI Slot# IRQ Priority

The Optimal default setting is Auto; the other settings are 3, 4, 5, 7, 9, 10, 11, 12, and 14.

## DMA Channel (0/1/3/5/6/7)

These options allow you to specify the bus type used by each DMA channel. The settings are PnP and ISA/EISA. The Optimal default setting is PnP.

## IRQ (3/4/5/7/9/10/11/12/14/15)

These options specify the bus that the specified IRQ line is used on. These options allow you to reserve IRQs for legacy ISA adapter cards. These options determine if the BIOS should remove an IRQ from the pool of available IRQs passed to devices that are configurable by the system BIOS. If more IRQs must be removed from the pool, the end user can use these options to reserve the IRQ by assigning an ISA-EISA setting to it.

On-board I/O is configured by the BIOS. All IRQs used by on-board I/O are configured as PCI-PnP. IRQ12 only appears if the PS/2 Mouse Support option in Advanced CMOS Setup is set to Disabled. The settings are ISA/EISA and PCI/PnP. The Optimal default setting is PCI/PnP.

## Reserved Memory Size

This option specifies the size of the memory area reserved for legacy ISA adapter cards. The settings are Disabled, 16K, 32K, and 64K. The Optimal default setting is Disabled.

## Reserved Memory Address

This option specifies the beginning address (in hex) of the reserved memory area. The specified ROM memory area is reserved for use by legacy ISA adapter cards. This option is disabled if the Reserved Memory Size option is set to Disabled. The Optimal default setting is C8000.

## PCI Device Search Order

The settings are First - Last and Last - First. The Optimal default setting is First - Last.

## BIOS Devnode for Shadow RAM

The Optimal default setting is Disabled.

# Peripheral Setup

## Power Interruption

The Optimal default setting is Enabled.

## Onboard FDC

Set this option to Enabled to enable the floppy drive controller on the motherboard. The settings are Auto (the BIOS automatically determines if the floppy controller should be enabled), Enabled, and Disabled. The Optimal default setting is Auto.

## Onboard Serial Port1

This option specifies the base I/O port address of serial port 1. The settings are Auto (the BIOS automatically determines the correct base I/O port address), Disabled, 3F8h, 2F8h, 2E8h, and 3E8h. The Optimal default setting is 3F8h.

## Onboard Serial Port2

This option specifies the base I/O port address of serial port 2. The settings are Auto (the BIOS automatically determines the correct base I/O port address), Disabled, 3F8h, 2F8h, 2E8h, and 3E8h. The Optimal default setting is 2F8h.

### **Serial Port2 Mode**

This option specifies the operating mode for serial port 2. This option only appears if the Onboard Serial Port2 option is not set to Disabled. The settings are IrDA (Infrared Dealer's Association protocol), Sharp-IR, Consumer, and Normal. The Optimal default setting is Normal.

### **IR Duplex Mode**

The Optimal default setting is N/A.

### **IR Receiver Pin**

The Optimal default setting is IRRX1.

## **Onboard Parallel Port**

This option specifies the base I/O port address of the parallel port on the motherboard. The settings are Disabled, Auto (the BIOS automatically determines the correct setting, 378, 278, or 3BC. The Optimal default setting is 378.

## **Parallel Port Mode**

This option specifies the parallel port mode. The Optimal default setting is Normal. The settings are:

| <b>Setting</b> | <b>Description</b>   |
|----------------|--|
| Normal         | The normal parallel port mode is used.   |
| Bi-Dir         | The parallel port can be used to data transfer in two directions.  |
| EPP            | The parallel port can be used with devices that adhere to the Enhanced Parallel Port (EPP) specification. EPP uses the existing parallel port signals to provide asymmetric bi-directional data transfer driven by the host device.                        |
| ECP            | The parallel port can be used with devices that adhere to the Extended Capabilities Port (ECP) specification. ECP uses the DMA protocol to achieve data transfer rates up to 2.5 Megabits per second. ECP provides symmetric bi-directional communication. |

### **EPP Version**

The Optimal default setting is N/A.



## **Parallel Port IRQ**

The settings are 5 and 7. The Optimal default setting is 7.

## **Parallel Port DMA Channel**

The Optimal default setting is N/A.

## **Onboard IDE**

This option specifies the IDE channel used by the on-board IDE controller. The settings are Disabled, Primary, Secondary, and Both. The Optimal and Fail-Safe default setting is Both.

## **Auto-Detect Hard Disks**

This option detects hard disk drives attached to each IDE channel and sets their parameters automatically.

## **Change Supervisor Password**

This option lets the user set a password which limits changes to specific BIOS parameters to those made by the Supervisor.

## **Change User Password**

This option lets the user set a password which limits changes to specific BIOS parameters to those made by an authorized User (or Supervisor).

## **Change Language Setting**

This option lets the user set the language used in BIOS Setup.

## **Auto Configuration with Optimal Settings**

The Optimal default values provide optimum performance settings for all devices and system features.

## **Auto Configuration with Fail-Safe Settings**

The Fail-Safe default settings consist of the safest set of parameters. Use them if the system is behaving erratically. They should always work but do not provide optimal system performance characteristics.

## **Save Settings and Exit**

Use this option to save changes made to the BIOS options.

## **Exit Without Saving**

Use this option to avoid changing the BIOS options.

## **Updating the System BIOS**

For information on updating the system's BIOS, see the README.TXT file delivered with the FLASHUTIL2M system software product, which is available from the online services of Intergraph Computer Systems. See the Preface for information on locating the online services.

---

## 6 Troubleshooting

Use this chapter to help identify the causes of problems that may occur on a TDZ 2000 GL2 or ExtremeZ GL2 workstation.

See the *System Reference* for information on opening the case and working with internal components. If you cannot resolve the problem or if the instructions direct you to call the Customer Response Center, contact Intergraph Computer Systems. See the Preface of this document for details.

|                              |    |
|------------------------------|----|
| System Power .....           | 62 |
| System Boot.....             | 62 |
| Sound .....                  | 65 |
| Video.....                   | 66 |
| Miscellaneous Hardware ..... | 66 |
| Network.....                 | 67 |

## System Power

### Fails to power on:

| <u>Reason</u>                        | <u>Solution</u>  |
|--------------------------------------|--|
| Power cord not connected properly.   | Verify that the power cord is properly connected to the power receptacle.                            |
| Power not available at the outlet.   | Verify power to the outlet has not been interrupted. Test the outlet with a known working appliance. |
| Power not available from the UPS.    | Verify the UPS is connected and operating properly.  |
| Internal power cables not connected. | Open case and ensure all power cables are connected.   |
| Faulty power cord.                   | Replace power cord.  |

## System Boot

### Does not boot from drive A:

| <u>Reason</u>  | <u>Solution</u>   |
|--|---|
| Corrupt BIOS on the flash EPROM.   | Power off the system and insert a floppy diskette containing the AMIBOOT.ROM file into the floppy disk drive. Depress and hold CTRL-HOME while powering up the system. Release the keys when the drive LED lights. If the BIOS remains corrupt, contact the Customer Response Center. |
| The boot sequence may be set to C, A, in which case the machine will not boot from A if there is an operating system on C. | Change the boot sequence. See Chapter 5.  |
| Corrupt boot disk, or boot disk does not have correct boot utilities.  | Replace the boot disk. See <i>System Reference</i> .  |

### Does not boot from the expected boot device:

| <b>Reason</b>  | <b>Solution</b>  |
|--|--|
| Operating system not on the system drive.  | Install the operating system as described in Chapter 7.  |
| BIOS attempts to boot from the wrong hard disk drive.  | Ensure the SCSI adapter for the system drive is installed physically below all other SCSI adapters.  |
| IDE hard disk drive is connected to IDE controller.  | BIOS cannot boot from a SCSI hard drive if an IDE hard disk drive is connected. Disconnect all IDE hard disk drives.   |
| System with internal SCSI disks attempts to boot from CD-ROM drive instead of a SCSI disk drive. | Do not boot the system with a bootable CD-ROM disc (such as the Windows NT software CD-ROM) in the CD-ROM drive. You may want to change the system's boot device order in the BIOS to boot from a SCSI disk drive before booting from the ATAPI CD-ROM drive. See Chapter 5. |

### Series of beeps and error message displays:

| <b>Message</b>          | <b>Explanation and Solution</b>  |
|-------------------------|--|
| Refresh Failure         | Bad memory refresh circuitry on the system board. Remove and reinstall DIMM(s). If error persists, replace the DIMM(s).    |
| Parity Error            | Parity error in the first 64 KB block of memory. Remove and reinstall DIMM(s). If error persists, replace DIMM(s).         |
| Base 64 KB Memory Error | Memory failure in the first 64 KB. Remove and reinstall the DIMM(s). If error persists, replace the DIMM(s).               |
| Timer Not Operational   | Memory failure in the first 64 KB, or Timer 1 on the system board is not functioning. Call the Customer Response Center.   |
| Processor Error         | The CPU on the system board generated an error. Call the Customer Response Center.   |
| 8042 - Gate A20 Failure | The BIOS cannot switch to protected mode, or the keyboard controller is malfunctioning. Call the Customer Response Center. |

| <b>Message</b>                          | <b>Explanation and Solution</b>   |
|---|---|
| Processor Exception Interrupt           | The CPU generated an exception interrupt. Call the Customer Response Center.                            |
| Display Memory Read/Write Error         | The video adapter is faulty. Call the Customer Response Center.   |
| ROM Checksum Error                      | The ROM checksum value does not match the value encoded in the BIOS. Call the Customer Response Center. |
| CMOS Shutdown Register Read/Write Error | The shutdown register for CMOS RAM failed. Call the Customer Response Center.                           |
| Cache Error/External Cache Bad          | The external cache is faulty. Call the Customer Response Center.  |

**CD-ROM drive is not recognized:**

| <b>Reason</b>                          | <b>Solution</b>  |
|--|--|
| CD-ROM drive power cable not attached. | Open case and ensure power cable is properly attached. See <i>System Reference</i> . |
| CD-ROM drive cable not attached.       | Open case and ensure cable is properly attached. See <i>System Reference</i> .       |

**System hard disk drive not recognized:**

| <b>Reason</b>   | <b>Solution</b>   |
|---|---|
| Hard disk drive power cable not attached.   | Open the case and ensure power cable is properly attached. See <i>System Reference</i> .                                    |
| Hard disk drive SCSI cable not attached.  | Open the case. Ensure the SCSI cable is properly attached at both ends. See <i>System Reference</i> .                       |
| A SCSI address conflict exists between the hard disk drive you installed and another SCSI device. | Remove the hard disk drive and change SCSI ID to an unused setting. See the documentation shipped with the hard disk drive. |
| SCSI termination is enabled on the hard disk drive you installed.                                 | Disable the SCSI termination. See the documentation shipped with the hard disk drive.                                       |
| Some viruses cause the system to not recognize hard disk drives.                                  | Run a virus scan program that checks the Master Boot Record. Clear any viruses detected by the program.                     |

**“Invalid configuration information for SLOT XX” message displays:**

| <b>Reason</b>  | <b>Solution</b>   |
|--|---|
| System is not properly configured to recognize the new ISA option board. | Use the Chipset menu parameters in BIOS Setup to reserve system resources for the board. See Chapter 5. |

**Total amount of memory does not display:**

| <b>Reason</b>                               | <b>Solution</b>  |
|---|--|
| Faulty DIMM(s).                             | Identify faulty DIMM(s) by swapping DIMM(s) until the faulty one is found. See <i>System Reference</i> . |
| DIMM(s) not properly seated into socket(s). | Ensure DIMM(s) are properly installed. See <i>System Reference</i> .                                     |

**I/O card parity error message displays:**

| <b>Reason</b>                                 | <b>Solution</b>  |
|---|--|
| Faulty option board is installed in ISA slot. | Remove ISA board, then restart the system. See <i>System Reference</i> . |

## Sound

**Sound cannot be heard:**

| <b>Reason</b>   | <b>Solution</b>  |
|---|--|
| Volume of speakers on multimedia keyboard is low or off.    | Adjust volume up, release Mute button or set slider switch to speaker position on multimedia keyboard. |
| Speaker cable is not properly connected.                    | Verify cable is properly connected.  |
| Volume is turned off in the program.                        | Double-click the speaker icon in the taskbar tray and increase the master volume.                      |
| Headphones are plugged into the multimedia keyboard.        | Unplug the headphones.   |
| Sound files work properly, but audio CD's produce no sound. | Verify the CD audio cable is connected between the CD-ROM drive and motherboard.                       |

## Video

### System powered on, but screen remains blank:

| <u>Reason</u>  | <u>Solution</u>   |
|--|---|
| Monitor not powered on.                              | Turn on power to the monitor.   |
| Monitor power cord not connected.                    | Connect monitor power cord to AC outlet and monitor.  |
| Video cable not properly installed.                  | Ensure video cable is connected to monitor and case.  |
| Graphics card not seated properly.                   | Open case and re-seat graphics card. See <i>System Reference</i> .  |
| Selected resolution is not supported by the monitor. | Select a supported resolution. See the video card documentation and README.TXT file for resolution details. |
| Improper video display driver installed.             | Remove the driver and install a valid driver. See Chapter 3.  |

## Miscellaneous Hardware

### CD-ROM drive LED does not light:

| <u>Reason</u>                          | <u>Solution</u>  |
|--|--|
| CD-ROM drive power cable not attached. | Open case and ensure power cable is properly attached. See <i>System Reference</i> . |

### Floppy disk drive LED does not light:

| <u>Reason</u>                               | <u>Solution</u>  |
|---|--|
| Floppy disk drive power cable not attached. | Open case and ensure power cable is properly attached. See <i>System Reference</i> . |

### Arrow keys or numbers do not work on keyboard number pad:

| <u>Reason</u>      | <u>Solution</u>         |
|--------------------|-------------------------|
| NUM LOCK disabled. | Press the NUM LOCK key. |



---

# Network

## Cannot connect to other systems on LAN:

| <b>Reason</b>                     | <b>Solution</b>   |
|-----------------------------------|---|
| Network cable disconnected.       | Reconnect network cable and ensure proper connection. If cable is properly connected, notify your System Administrator. |
| Incorrect software configuration. | Notify your System Administrator.   |

## Cannot plot to network printer or plotter on LAN:

| <b>Reason</b>                                      | <b>Solution</b>                                    |
|--|--|
| Network cable disconnected.                        | Reconnect network cable, ensure proper connection. |
| Plotter not added to Print Manager on your system. | Notify your System Administrator.                  |
| Plot node does not recognize your system.          | Notify your System Administrator.                  |



## 7 Reinstalling System Software

Follow the instructions in this chapter only if you need to reinstall the operating system and associated system software on your TDZ 2000 GL2 or ExtremeZ GL2 workstation. Before you reinstall the software, ensure that you read and understand this entire chapter.

**NOTE** If you are setting up an ExtremeZ workstation for the first time, see the *ExtremeZ Customer Welcome Letter*. The *ExtremeZ Customer Welcome Letter* provides step-by-step instructions for initial setup of an ExtremeZ workstation. Use the information in this chapter only if you have to reinstall the operating system and associated system software on your ExtremeZ workstation.

|   |    |
|---|----|
| Before You Begin .....  | 70 |
| System Software Products.....   | 71 |
| TDZ 2000 GL2 .....  | 71 |
| ExtremeZ GL2 .....  | 72 |
| Installing Windows NT Workstation 4.0 .....                                 | 73 |
| Disabling Command Queuing .....   | 74 |
| Enabling Bus Mastering for IDE/ATAPI Devices .....                          | 75 |
| Installing the Creative Labs Sound Blaster Pro 16 Driver .....              | 75 |
| Installing Windows 95 or Windows 98.....                                    | 76 |
| Installing the Creative Labs Sound Blaster Pro 16 Driver .....              | 77 |
| Installing Windows 95 or Windows 98 with an Installed Network Adapter ..... | 78 |
| Enabling Bus Mastering for IDE/ATAPI Devices .....                          | 78 |
| Disabling the Active Desktop .....  | 79 |
| Updating the Operating System.....  | 79 |

## Before You Begin

Have the following items available:

- ◆ The information that you recorded in Chapter 2, “Setting Up the Software.”
- ◆ Operating system software CD-ROM, Service Pack CD-ROM (Windows NT), associated diskettes, and documentation. Make sure you have the Setup diskettes (Windows NT Workstation 4.0) or the Boot diskette (Windows 95/98), as appropriate.
- ◆ Backup diskettes you created according to instructions in Chapter 2, “Setting Up the Software.” You can also create backup diskettes by inserting the System CD-ROM into any computer running Windows NT, Windows 95, or Windows 98 and running InterSite Version Manager. Create backup diskettes for the system software listed under “System Software Products” in this chapter.
- ◆ Backup diskettes and documentation delivered with any expansion cards or additional peripheral devices purchased from Intergraph Computer Systems.
- ◆ The *Late-Breaking News* document delivered with the system, if applicable.

You can find the system software on backup diskettes that you created, on the InterSite CD-ROM, on diskettes provided by Intergraph Computer Systems, or on the operating system CD-ROM. If you did not create backup diskettes of drivers or other system software products, you can create them from the InterSite CD-ROM as described earlier in this chapter. System software is also probably available on the operating system CD-ROM or on backup diskettes delivered with expansion cards.

**NOTE** If your system is an ExtremeZ workstation, the system was shipped with the Drivers and Applications product on the Connectivity Plus CD-ROM. Drivers and Applications is a set of system drivers and applications specifically for rebuilding an ExtremeZ workstation. For more information, see “Drivers and Applications for ExtremeZ Systems” in this chapter.

**NOTE** You must install certain drivers from backup or other diskettes. The correct driver versions may not be on CD-ROM. If a driver version is delivered on backup diskette or in Version Manager, that version should be used instead of what is available on the operating system CD-ROM.

Driver software is routinely improved and updated. Use InterSite Version Manager, or visit Intergraph Computer Systems on the World Wide Web and vendor bulletin boards for new and updated drivers.

Review the *Late-Breaking News* document delivered with your system for any additional tasks you may have to perform during reinstallation.

# System Software Products

## TDZ 2000 GL2

The following table lists drivers and other system software products installed on various configurations of TDZ 2000 GL2 systems. Products available for your system, but not listed here, are available on an operating system software CD-ROM or are delivered with an expansion card or additional peripheral device.

| <b>Description</b>                       | <b>Windows NT 4.0</b> | <b>Windows 95/98</b> |
|--|-----------------------|----------------------|
| Accel Graphics AccelSTAR II video driver | ACCEL2DRVNT           | ACCEL2DRV95          |
| Matrox G200 video driver                 | MILL2DRVNT            | MILL2DRVW95          |
| Matrox DigiDesktop driver                | DIGIDTOP              | –                    |
| Intense 3D Pro 2200s video driver        | INTENSEDRV            | –                    |
| Intergraph RealizM II                    | REALIZMDRV            | –                    |
| Creative Labs Sound Blaster driver       | SNDBLSTNTDRV          | SNDBLSTW9X           |
| Logitech wheel mouse driver              | LMOUSE                | LMOUSE               |
| Primax mouse driver                      | –                     | P MOUSE              |
| PIIX4 driver                             | –                     | PIIX4W95R2           |
| IKON PCI driver                          | IKONPCIDRV            | –                    |
| 3COM 3C905B network adapter driver       | 3COM3C90X             | 3COM3C90X            |
| Symbios SCSI driver                      | SYMSCSI               | SYMSCSI95            |
| Symbios LVD SCSI adapter driver          | SYMLVDSCSI            | –                    |
| Adaptec SCSI driver                      | 2940SCSIDRV           | 2940SCSI95           |
| OLICOM Token Ring network adapter driver | PCITOKRNG             | PCITOKRNG            |
| 56KB modem driver                        | 56KMODEM              | 56KMODEM             |
| InterSite Welcome                        | WELCOME               | WELCOME              |
| InterSite Version Manager                | VERMANAGER            | VERMANAGER           |
| InterSite Diskeeper Lite                 | DKLITE                | –                    |
| InterSite DMI Console                    | DMI                   | –                    |
| InterSite Manager                        | IM                    | –                    |
| InterSite Watchdog                       | WATCHDOG              | –                    |
| SMART disk driver                        | SMARTDRV              | –                    |

| <u>Description</u>  | <u>Windows NT 4.0</u> | <u>Windows 95/98</u> |
|---|-----------------------|----------------------|
| Automatic Shutdown Utility  | SHUTDOWN              | –                    |
| IE 4.01 Settings file   | –                     | IE4SETTINGS          |
| Windows 95 Boot Diskette  | –                     | W95BOOTDSK           |
| Windows 98 Boot Diskette  | –                     | BOOTW98              |
| Quick-Fix Engineering Update                                      | QFE_NT*               | QFE_W*               |
| BIOS and Flash Program Utility<br>(available via online services) | FLASHUTIL2M           | FLASHUTIL2M          |

## ExtremeZ GL2

If you have an ExtremeZ system, it was shipped with the Drivers and Applications product on the Connectivity Plus CD-ROM. Drivers and Applications is a set of system drivers and applications specifically for rebuilding an ExtremeZ workstation. When this document instructs you to install a driver from backup diskette, use the Connectivity Plus CD-ROM instead, and type the path name for the driver as follows:

*drive*:\**drivers and apps**\*directory*

where *drive* is the drive letter for your system's CD-ROM drive, and *directory* is the directory name you want to use. Select from the following drivers and applications:

| <u>Directory</u> | <u>Description</u>                    |
|------------------|---------------------------------------|
| DMI              | InterSite DMI Console                 |
| MILL2DRVNT       | Matrox Millennium II video driver     |
| QFE_NT*          | Quick-Fix Engineering Update software |
| SMARTDRV         | SMART Drive driver                    |
| VERMANAGER       | InterSite Version Manager             |
| WATCHDOG         | InterSite Watchdog                    |
| WELCOME          | InterSite Welcome                     |
| IM               | InterSite Manager                     |
| DKLITE           | InterSite Diskeeper Lite              |

---

## Installing Windows NT Workstation 4.0

Depending on your system's configuration, you will need some or all of the following system software during the installation process:

- ◆ SCSI adapter driver
- ◆ Video display adapter driver
- ◆ Network adapter driver
- ◆ Sound adapter driver
- ◆ QFE update software

**NOTE** If you want to boot from a SCSI hard disk drive, you must change the 2nd Boot Device option in AMIBIOS Setup from 1st IDE-HDD to SCSI.

Follow the instructions in *Start Here* to install Windows NT.

Do the following *during* installation of the operating system:

- ◆ Select Custom Setup when prompted to select a Setup type.
- ◆ On a system with internal SCSI disk drives and a SCSI adapter, press the **S** key to install the SCSI adapter driver from backup diskette. Select `Other (Requires disk provided by a hardware manufacturer)` from the list and press ENTER. Insert the diskette with the SCSI adapter driver into the floppy disk drive, and then press ENTER.
- ◆ Specify a driver for the CD-ROM drive by pressing the **S** key and then selecting `IDE CD-ROM (ATAPI 1.2) / PCI IDE Controller` from the list.
- ◆ On single-processor systems, when prompted, select `Standard PC`. This will load the single-processor kernel and HAL, providing better performance.

On dual-processor systems, if prompted, select `MPS Multiprocessor`. This will load the multi-processor kernel and HAL, enabling the system to take advantage of the second processor.

- ◆ Allow Setup to configure the network only if you have an installed network adapter, and only if the system is connected to the network.
- ◆ Create an Emergency Repair Disk when prompted to do so.

Do the following *after* installation of the operating system:

- ◆ Install drivers or other system software from any backup diskettes. System software delivered on backup diskette is usually more current than system software on the

operating system CD-ROM. Alternatively, you can install the drivers or other system software from the Windows NT CD-ROM if you do not have them on diskette.

- ◆ Perform any additional installation and configuration tasks described in the *Late-Breaking News* document delivered with your system.
- ◆ Configure the system as described in Chapter 3, “Configuring the System.”
- ◆ If your system was running Windows NT 4.0 Service Pack software, install this software after installing drivers and other system software, and after installing any application software products.
- ◆ Perform any operational changes required for your system as described in Chapter 4, “Operating Notes.”

Do the following *after* you install the Windows NT Service Pack:

- ◆ If you created a Quick-Fix Engineering (QFE) backup diskette from Version Manager during any previous initial system configuration, install the QFE update software. See the README.TXT file on the QFE diskette for more information.
- ◆ Complete the additional installation and configuration tasks in this section.

## Disabling Command Queuing

In systems equipped with the Adaptec 2910 SCSI adapter, you can improve both system and SCSI peripheral performance by disabling command queuing in the Windows NT Registry.

**WARNING** Do not change values in the Registry other than as directed. If you introduce incorrect values into the Registry, you may cause serious operating system problems, and you may have to reinstall Windows NT. If you change values in the Registry that make your system unusable, you may be able to restart the system and use the Last Known Good Configuration option to undo the damage. See the operating system documentation for more information on the Last Known Good Configuration option.

**To disable command queuing:**

1. Start the Registry Editor (REGEDT32.EXE) to open the Registry.
2. Open the following subkey in the Registry:  
`HKEY_LOCAL_MACHINE\SYSTEM\CurrentControlSet\Services\aic78xx`
3. From the Edit menu, select Add Key.
4. Type **Device** into the Key Name box, and then select OK. Do not set a Class value.
5. Open the following subkey in the Registry:  
`HKEY_LOCAL_MACHINE\SYSTEM\CurrentControlSet\Services\aic78xx\  
Device`



6. From the Edit menu, select Add Value.
7. Type **DisableTaggedQueuing** into the Value Name box.
8. Select REG\_DWORD for the Data Type, and then select OK.
9. Type **1** into the Data box.
10. Set the Radix value to Hex, and then select OK.
11. Exit from the Registry Editor and restart the system.

## Enabling Bus Mastering for IDE/ATAPI Devices

Your system shipped with bus mastering for IDE/ATAPI devices enabled. If you reinstall Windows NT 4.0 and Service Pack 3 software, you should enable IDE/ATAPI bus mastering.

**NOTE** If you have a CD-Recorder drive installed, do not enable IDE/ATAPI bus mastering. The CD-Recorder drive is incompatible with IDE/ATAPI bus mastering.

### To enable IDE/ATAPI bus mastering:

1. Ensure that the operating system, Service Pack 3 software, and QFE update software (QFE\_NTW) are installed.

**NOTE** The QFE update software includes an updated ATAPI device driver that should be installed after Service Pack 3.

**NOTE** For reasons of system performance, if a TR-4i tape drive or a Zip drive is installed, do not enable DMA use on the IDE channel to which the drive is connected. A TR-4i tape drive or Zip drive is usually connected to Channel 0 when installed at the factory.

2. Insert the Windows NT 4.0 Service Pack 3 CD-ROM into your system's CD-ROM drive.
3. In Explorer or File Manager, navigate to the \SUPPORT\UTILS\I386 directory.
4. Double-click DMACHECK.EXE. The ATAPI DMA support dialog displays.
5. The Current DMA Usage boxes indicate which channels have IDE/ATAPI devices. For each channel with an IDE/ATAPI device, click Enabled; then click OK.
6. Restart the system.

## Installing the Creative Labs Sound Blaster Pro 16 Driver

To install the Sound Blaster Pro 16 adapter driver, follow the instructions found in the README.TXT file, located in the *DRIVER* directory on the *SYSTEM DRIVE*.

## Installing Windows 95 or Windows 98

Depending on your system's configuration, you will need some or all of the following system software during the installation process:

- ◆ Windows 95/98 Operating System CD-ROM
- ◆ SCSI adapter driver
- ◆ Video display adapter driver
- ◆ Network adapter driver
- ◆ Sound card driver
- ◆ Mouse driver

When reinstalling Windows 95 or Windows 98, you must also reinstall various system software products during and after operating system Setup.

You can create backup diskettes for these products using InterSite Version Manager.

See Chapter 2, "Setting Up the Software," for more information on using InterSite Version Manager to create system software backup diskettes.

### **To install Windows 95:**

1. Insert the Windows 95/98 boot diskette in the floppy disk drive.
2. Insert the Windows 95/98 CD-ROM in the CD-ROM drive.
3. Start (or restart) the system.
4. At the Startup Menu, select the option to install Windows 95/98.

If you are installing Windows 95 or Windows 98 on a system on which another operating system or a previous version exists, you may have to partition and format the system's hard disk before installing the operating system. An option on the Startup Menu allows you to exit to MS-DOS and use the `fdisk` and `format` commands.

**CAUTION** Be sure to make a backup copy of your data and/or programs before partitioning and formatting the system's hard disk. All data on the hard disk will be destroyed during the `fdisk` and `format` process. Once you have completed these tasks and reinstalled operating system, you must reinstall any application software and data that you want to use.

**CAUTION** Make sure that the system disk drive is partitioned and formatted with the File Allocation Table (FAT) file system before attempting to install Windows 95/98, or the installation will fail.

Follow the instructions in *Introducing Windows 95* or *Getting Started* to install Windows 95 or Windows 98, respectively. As you install the operating system:

- ◆ Select the default responses during the Setup process.
- ◆ Allow Setup to configure the network only if you have an installed network adapter, and only if the system is connected to the network.
- ◆ Create a Startup diskette when prompted.
- ◆ While operating system files are being copied to the system, you are prompted for the Setup boot diskette. This occurs even if the Setup boot diskette is already inserted in the floppy disk drive. Select OK to continue.

Next, you are notified that a CD-ROM driver file (such as OAKCDROM.SYS or TAISATAP.SYS) could not be found on the Setup boot diskette. In the dialog that displays, specify that the file should be copied from **a:\**, and then select OK.

After installing the operating system:

- ◆ Install drivers or other system software from any backup diskettes. System software delivered on backup diskette is usually more current than system software on the operating system CD-ROM. Alternatively, you can install the drivers or other system software from the Windows 95/98 CD-ROM if you don't have them on diskette.

As shipped from the factory, the system's hard disk drive contains Windows 95/98 Setup files in the C:\WINDOWS\OPTIONS\CABS directory, as compressed .CAB files. If the CABS directory is deleted from the system's hard disk, you must have access to a Windows 95/98 CD-ROM to use the operating system Setup files.

- ◆ Perform any additional installation and configuration tasks described in the *Late-Breaking News* document delivered with your system.
- ◆ Configure the system as described in Chapter 3, "Configuring the System."
- ◆ Perform any operational changes required for your system as described in Chapter 4, "Operating Notes."
- ◆ You can install MS-DOS Microstation drivers, available from the Intergraph Bulletin Board Service (IBBS).

## Installing the Creative Labs Sound Blaster Pro 16 Driver

To install the Sound Blaster Pro 16 adapter driver, use the Plug and Play feature of Windows 95/98 to install the driver. Follow the instructions found in the README.TXT file, located in the *DRIVER* directory on the *SYSTEM DRIVE*.

## Installing Windows 95 or Windows 98 with an Installed Network Adapter

If you reinstall Windows 95 or Windows 98 on a system with an installed network adapter, the adapter may not function after completing Setup.

### **To re-enable network adapter operation after installing Windows 95 or Windows 98:**

1. Go to Start/Settings/Control Panel/System/Device Manager.
2. In the list of devices displayed, double-click Other Devices.
3. Under Other Devices, click the network adapter installed in your system, and then click Remove.
4. Close Device Manager, and then restart the system.
5. As the operating system starts, it will detect the network adapter and prompt you to install the network adapter's driver software. Follow the instructions displayed. You will need the diskette containing the network adapter's driver software.

## Enabling Bus Mastering for IDE/ATAPI Devices

Your system shipped with bus mastering for IDE/ATAPI devices enabled. If you reinstall the operating system, you should enable IDE/ATAPI bus mastering.

**NOTE** If you have a CD-Recorder drive installed, do not enable IDE/ATAPI bus mastering. The CD-Recorder drive is incompatible with IDE/ATAPI bus mastering.

### **To enable IDE/ATAPI bus mastering:**

1. Go to Start/Settings/Control Panel/System/Device Manager/Disk Drives.
2. Click a disk drive, then click Properties, and then click Settings.
3. Click the DMA check box, and then click OK.
4. Repeat steps 2 and 3 for any additional disk drives.
5. In Device Manager, right-click the CD-ROM drive, then click Properties, and then click Settings.
6. Click the DMA check box, and then click OK.
7. Restart the system.

## Disabling the Active Desktop

If you ever decide to disable the Active Desktop feature of Windows 95 OSR 2.5 or Windows 98, you can do so by doing the following:

### To disable the Active Desktop:

1. Go to Start/Settings/Control Panel/Display, and then select the Web tab.
2. Remove the check from the checkbox for the View my Active Desktop as a web page option, and then click OK.
3. Click No when prompted. The classic Windows 95/98 desktop displays.

## Updating the Operating System

Microsoft Service Packs and Service Releases contain the latest improvements and system fixes for Microsoft operating systems. Service Packs and Releases are created by Microsoft for post-release support. You can obtain them from Microsoft's World Wide Web and FTP sites free of charge.

**CAUTION** If Intergraph provides a Service Pack or Service Release through the IBBS or with a product or system, it has been certified against Intergraph hardware as described in the announcement of its availability. If you obtain a Service Pack or Service Release from any other source, be aware that it may not be certified against your Intergraph hardware.



## 8 Using System Resources

This chapter provides information on using system resources, such as interrupt requests (IRQs), direct memory access (DMA) channels, input/output (I/O) addresses, and memory addresses. The chapter covers specific Peripheral Component Interconnect (PCI) and Industry Standard Architecture (ISA) devices offered by Intergraph as system options. Intergraph Computer Systems has determined that the devices discussed in this chapter require specific resource settings to ensure proper system operation.

See Chapter 5, “Configuring the BIOS,” for information on running the BIOS Setup program and changing BIOS parameter settings.

See the *System Reference* for additional information on system resources.

|   |    |
|---|----|
| System Resources.....                     | 82 |
| ISA Bus Interrupt (IRQ) Assignments ..... | 82 |
| Direct Memory Access (DMA) Channels.....  | 82 |
| Input/Output (I/O) Addresses .....        | 82 |
| Memory Addresses.....                     | 84 |
| Using System Resources.....               | 85 |
| PCI Devices.....                          | 86 |

## System Resources

The following sections list the available system resources. See the vendor documentation delivered with an expansion card or a peripheral device for instructions on how to use these resources.

### ISA Bus Interrupt (IRQ) Assignments

| <u>IRQ</u> | <u>Assignment</u>                  | <u>IRQ</u> | <u>Assignment</u>           |
|------------|------------------------------------|------------|-----------------------------|
| 0          | Reserved (timer/counter)           | 8          | Reserved (real-time clock)  |
| 1          | Reserved (keyboard controller)     | 9          | USB or Windows Sound        |
| 2          | Reserved (interrupt controller)    | 10         | LAN                         |
| 3          | Serial ports COM 2/COM 4           | 11         | SCSI                        |
| 4          | Serial ports COM 1/COM 3           | 12         | PS/2 mouse                  |
| 5          | Sound card or parallel port LPT 2  | 13         | Reserved (math coprocessor) |
| 6          | Reserved (floppy drive controller) | 14         | Primary IDE                 |
| 7          | Parallel port LPT 1                | 15         | Secondary IDE               |

### Direct Memory Access (DMA) Channels

| <u>DMA Channel</u> | <u>Data Width</u> | <u>Assignment</u>                  |
|--------------------|-------------------|------------------------------------|
| 0                  | 8b or 16b         | Open                               |
| 1                  | 8b or 16b         | Second choice of ECP parallel port |
| 2                  | 8b or 16b         | Floppy drive controller            |
| 3                  | 8b or 16b         | First choice of ECP parallel port  |
| 4                  | NA                | DMA controller to cascade channel  |
| 5                  | 16b               | Open                               |
| 6                  | 16b               | Open                               |
| 7                  | 16b               | Open                               |

### Input/Output (I/O) Addresses

| <u>I/O Address (hex)</u> | <u>Size</u> | <u>Assignment</u>      |
|--------------------------|-------------|------------------------|
| 0000 – 000F              | 16 bytes    | DMA controller 1       |
| 0020 – 0021              | 2 bytes     | Interrupt controller 1 |
| 0040 – 0043              | 4 bytes     | Timer/counter 1        |
| 0048 – 004B              | 4 bytes     | Timer/counter 2        |
| 0060                     | 1 byte      | Keyboard controller    |
| 0061                     | 1 byte      | NMI and speaker        |



| <b>I/O Address (hex)</b> | <b>Size</b> | <b>Assignment</b>                             |
|--------------------------|-------------|---|
| 0064                     | 1 byte      | Keyboard controller                           |
| 0070 bit7                | 1 bit       | Enable NMI                                    |
| 0070 bit0:6              | 7 bits      | RTC address (max. 128 bytes)                  |
| 0071                     | 1 byte      | RTC data byte                                 |
| 0080 – 008F              | 16 bytes    | DMA page registers                            |
| 00A0 – 00A1              | 2 bytes     | Interrupt controller 2                        |
| 00C0 – 00DF              | 32 bytes    | DMA controller 2                              |
| 0170 – 0177              | 8 bytes     | Secondary IDE channel                         |
| 01F0 – 01F7              | 8 bytes     | Primary IDE channel                           |
| 0200 – 0207              | 8 bytes     | Add-in card; audio/game port                  |
| 0220 – 022F              | 16 bytes    | Add-in card; audio (Sound Blaster compatible) |
| 0240 – 024F              | 16 bytes    | Add-in card; audio (Sound Blaster compatible) |
| 0278 – 027F              | 8 bytes     | Parallel port 2                               |
| 02E8 – 02EF              | 8 bytes     | COM 4   |
| 02F8 – 02FF              | 8 bytes     | COM 2   |
| 0300 – 0301              | 2 bytes     | Add-in card; MIDI                             |
| 0330 – 0335              | 6 bytes     | Add-in card; MIDI                             |
| 0370 – 0375              | 6 bytes     | Floppy drive channel 2                        |
| 0376                     | 1 byte      | Secondary IDE channel command                 |
| 0377 write               | 1 byte      | Floppy drive channel 2 command                |
| 0377 bit7 read           | 1 bit       | Floppy drive channel 2 disk change status     |
| 0377 bit0:6              | 7 bits      | Secondary IDE channel status                  |
| 0378 – 037F              | 8 bytes     | Parallel port 1                               |
| 03B4 – 03B5              | 2 bytes     | Add-in card; VGA                              |
| 03BA                     | 1 byte      | Add-in card; VGA                              |
| 03BC – 03BF              | 4 bytes     | Parallel port 3                               |
| 03C0 – 03CA              | 11 bytes    | Add-in card; VGA                              |
| 03CC                     | 1 byte      | Add-in card;VGA                               |
| 03CE – 03CF              | 2 bytes     | Add-in card; VGA                              |
| 03D4 – 03D5              | 2 bytes     | Add-in card; VGA                              |
| 03DA                     | 1 byte      | Add-in card; VGA                              |
| 03E8 – 03EF              | 8 bytes     | COM 3   |
| 03F0 – 03F5              | 5 bytes     | Floppy drive channel 1                        |
| 03F6                     | 1 byte      | Primary IDE channel command                   |
| 03F7 write               | 1 byte      | Floppy drive channel 1 command                |
| 03F7 bit7 read           | 1 bit       | Floppy drive channel 1 disk change status     |

| <b>I/O Address (hex)</b> | <b>Size</b> | <b>Assignment</b>                               |
|--------------------------|-------------|---|
| 03F7 bit0:6 read         | 7 bits      | Primary IDE channel status                      |
| 03F8 – 03FF              | 8 bytes     | COM 1   |
| 0CF8 – 0CFB              | 4 bytes     | PCI configuration address registers (DW access) |
| 0CFC – 0CFF              | 4 bytes     | PCI configuration data registers                |
| FF00 – FF07              | 8 bytes     | IDE bus master registers                        |
| FFA0 – FFA7              | 8 bytes     | Primary IDE bus master registers                |
| FFA8 – FFAF              | 8 bytes     | Secondary IDE bus master registers              |

## Memory Addresses

| <b>Memory Address</b>      | <b>Range</b>             | <b>Size</b> | <b>Description</b>                     |
|----------------------------|--------------------------|-------------|--|
| 0K – 512K                  | 00000000 – 0007FFFF      | 512K        | DOS conventional memory                |
| 512K – 640K                | 00080000 – 0009FFFF      | 128K        | DOS conventional memory or memory hole |
| 640K – 768K                | 000A0000 – 000BFFFF      | 128K        | VGA memory and BIOS                    |
| 768K – 896K                | 000C0000 – 000DFFFF      | 128K        | Expansion card BIOS and buffer         |
| 896K – 1024K               | 000E0000 – 000FFFFFFF    | 128K        | System BIOS                            |
| 1024K – 15360K             | 00100000 – 00EFFFFFFF    | 15.36M      | Main memory                            |
| 15.36M – 16.384M           | 00F00000 – 00FFFFFFF     | 1024K       | ISA memory hole (optional)             |
| 16.384M –<br>Top of memory | 01000000 – Top of memory | xxxx        | Main memory                            |
| 16.384M –<br>1048.576M     | 01000000 – 3FFFFFFF      | 1032.192M   | Maximum allowable memory               |
| 1G – (4G – 20M)            | 04000000 – FEBFFFFFFF    | (3G – 20M)  | PCI/AGP memory                         |
| (4G – 20M) –<br>(4G – 19M) | FEC00000 – FECFFFFFFF    | 1024K       | APIC configuration space               |
| (4G – 19M) –<br>(4G – 18M) | FED00000 – FEDFFFFFFF    | 1025K       | PCI/AGP memory                         |
| (4G – 18M) –<br>(4G – 17M) | FEE00000 – FEEFFFFFFF    | 1024K       | APIC configuration space               |
| (4G – 17M) –<br>(4G – 2M)  | FEF00000 – FFDFFFFFFF    | 15M         | PCI/AGP memory                         |
| (4G – 2M) – 4G             | FFE00000 – FFFFFFFF      | 2M          | High system BIOS                       |

# Using System Resources

Most ISA devices installed in the system require you to reserve an IRQ. PCI devices also need to use an IRQ, but since they share system resources they can use the same IRQ. At least one IRQ must be left unassigned, for use with any PCI devices installed in your system.

The system has a limited number of open IRQs. To install more ISA devices than you have open IRQs, you must disable one unused system port for each excess ISA device, unless the device does not require an IRQ.

## To reserve an IRQ for an installed device:

1. Restart the system and start the BIOS Setup program.
2. On the PCI/PnP screen, select the IRQ you want to reserve.
3. Change the setting for the selected IRQ to ISA/EISA.
4. Save the changes and exit from the BIOS Setup program.

The following expansion cards require specific system resource settings, as noted:

| <b>Expansion card<br/>(installed in the system)</b> | <b>Resources<br/>required</b> | <b>BIOS Setup<br/>parameter settings</b>       |
|---|-------------------------------|--|
| First modem (Windows NT)                            | COM3, IRQ 4                   | Disable serial port 1 (COM1);<br>reserve IRQ 4 |
| First parallel printer adapter                      | Base address 278              | None   |
| Second parallel printer adapter                     | Base address 3BC              | None   |
| 3Com network adapter                                | IRQ 10 (default)              | Reserve IRQ 10                                 |

On a system running Windows 95 or Windows 98, ensure the following system resources are set as noted:

| <b>System resource</b>         | <b>BIOS Setup parameter settings</b>                      |
|--------------------------------|---|
| Plug and Play operating system | On the PCI/PnP screen, set Plug and Play Aware O/S to Yes |
| Serial port 1 COM1             | Reserve IRQ 4 (if port is to be used)                     |
| Serial port 2 COM2             | Reserve IRQ 3 (if port is to be used)                     |
| Parallel port LPT1             | Reserve IRQ 7 (if port is to be used)                     |

## PCI Devices

The system's PCI expansion slots comply with the PCI 2.1 specification. Devices that comply with the PCI 2.1 specification are fully plug-and-play. You do not have to configure them after installation.

Some older PCI device drivers cannot share an interrupt, which is a violation of the PCI 2.1 specification. If you install a device that uses such a driver, you must free an IRQ for the device to work in the system.

## **Returned Goods Authorization (RGA) Form**

---

**Date Returned** \_\_\_\_\_ **Base Serial No.** \_\_\_\_\_  
(On white bar code ID plate on back of base unit)

**RGA No.** \_\_\_\_\_ (From Intergraph Customer Response Center)

**From Customer Name** \_\_\_\_\_

**Customer Contact** \_\_\_\_\_ **Phone** \_\_\_\_\_

**Mail Address** \_\_\_\_\_

\_\_\_\_\_

\_\_\_\_\_

\_\_\_\_\_

**Reason for Return** \_\_\_\_\_

\_\_\_\_\_

\_\_\_\_\_

\_\_\_\_\_

\_\_\_\_\_

\_\_\_\_\_

\_\_\_\_\_

**NOTE** All returned equipment **MUST** be shipped in original Intergraph packaging to obtain warranty service.

**WARNING** **Back up disk drives before returning equipment. Intergraph is not responsible for data lost in shipping or repair process.**

## **Warranty Procedure**

---

Some malfunctioning equipment cannot be repaired in the field, and you must return it to Intergraph for repair. Follow these steps to obtain a Returned Goods Authorization (RGA) log number and return the malfunctioning equipment.

1. Determine the serial number of the system. The serial number is located on the white bar code identification label on the back of the base unit.
2. Call the Intergraph Customer Response Center at 1-800-633-7248, and identify your call to the operator as a Warranty Call. After giving the operator the serial number of the system, you will be assigned a RGA log number.
3. Complete the RGA Form on the previous page, entering the RGA log number obtained from the Customer Response Center. Ensure that the address in the From section is the location to which you want the equipment to be returned.
4. Place the RGA form in the box containing the equipment. This form must accompany returned equipment.
5. Secure a Repair Depot address label from the next page to the box containing the equipment.
6. Ship the box containing the equipment to Intergraph.

When the service activity has been completed by Intergraph, the repaired or replaced equipment will be shipped to the address listed on the RGA Form.

**NOTE**      Parts damaged during shipping and parts not covered by the warranty are liable for repair charges.

---

**TO Repair Depot RGA No. \_\_\_\_\_**  
**Intergraph Corporation**  
**9805 Kellner Road**  
**Huntsville AL 35894**

---

**TO Repair Depot RGA No. \_\_\_\_\_**  
**Intergraph Corporation**  
**9805 Kellner Road**  
**Huntsville AL 35894**

---

**TO Repair Depot RGA No. \_\_\_\_\_**  
**Intergraph Corporation**  
**9805 Kellner Road**  
**Huntsville AL 35894**

---

